

Protura™ 1.7.4 Robotic Couch System

6 Degrees of Freedom Patient Positioning

User Guide

CIVCO

CE

Customer Support

Technical support is available from ProturaSupport@civcort.com or by calling 866.851.4355 from 7 am to 6 pm CST, Monday through Friday, excluding holidays.

Sales support is available at 800.842.8688.

About this Document

The notes and symbols used in this manual have the following meanings:

WARNING



- *Calls attention to a procedure, practice or condition which, if not correctly performed or adhered to, could result in injury or death.*

NOTE

Provides additional information or application hints.



Contact CIVCO to recycle per EU Directives.
Kontakt CIVCO vedrørende genbrug i overensstemmelse med EU-direktiver.
Neem contact op met CIVCO voor recycling volgens EU-Richtlijnen.
Ota yhteyks CIVCO:on koskien EU-direktiivien mukaista kierrätystä.
Contacter CIVCO pour recycler le produit conformément aux directives européennes.
Zum Recycling nach EU-Richtlinien CIVCO kontaktieren.
Επικοινωνήστε με τη CIVCO για να διαθέσετε σύμφωνα με τις οδηγίες της ΕΕ.
Contattare CIVCO per il riciclaggio secondo le Direttive EU.
リサイクルに関しましてはE J 本部までご連絡ください。
Tå kontakt med CIVCO for å gjennomføring av gjenvinning i henhold til aktuelle EU-direktiver.
Contacte a CIVCO para a reciclagem de acordo com as normas da UE.
联系CIVCO以按照欧盟指令进行回收。
Contacte con CIVCO para el reciclado según las Directrices de la UE.
Kontakta CIVCO för återanvändning enligt EU-direktiv.
AB Direktifleri uyarınca geri dönüştürmek için CIVCO ile iletişime geçin.

Table of Contents

1	Protura	1
2	Getting Started	4
2.1	Hardware Overview	4
2.1.1	Range of Motion	6
2.2	Software Overview	7
3	Alignment	11
3.1	Alignment Fixture	11
3.2	Isocenter Alignment	12
4	Test Procedure	14
5	Using Protura	16
5.1	Managing Patient Information	16
5.1.1	Create Patient Record	16
5.1.2	Open Patient Record	17
5.1.3	Edit Patient Record	18
5.1.4	Define Course Identifiers	19
5.1.5	Close Patient Record	19
5.1.6	Delete Patient Record	20
5.2	Patient Moves	21
5.2.1	Change IGRT System	21
5.2.2	Change Move Speed	21
5.2.3	Couch Pedestal Location	22
5.2.4	Move Patient - Proposed Values	22
5.2.5	Move Out of Range	24
5.2.6	Move Successful	25
6	Protura Workflows	26
6.1	General Protura Workflow	26
6.2	Protura Workflow - Varian Integration without Pedestal Shifts	28
6.3	Protura Workflow - Varian Integration with Pedestal Shifts	32
6.4	Protura Workflow - Varian Integration without Protura	37
6.5	Protura Workflow - Elekta Integration	39
6.6	Protura Workflow - Remote Control	41
6.7	Protura Workflow - Remote Control with Linac Integration	44
6.8	Protura Workflow - File Import	49
7	Reports	52
7.1	Daily Move Report	53
7.2	Patient Move Report	54
7.3	Preview Report Overview	55
8	Configurations and Settings	58
8.1	System Settings	59
8.2	Couch Pedestal Configuration	61
8.2.1	Couch Pedestal Configuration Relationship	63
8.3	IGRT Coordinate System Configuration	64
8.3.1	IGRT Coordinate System Relationship	67
8.3.2	Override IGRT Data Type (Absolute or Relative Coordinates)	68
8.4	Isocenter Alignment	68
8.5	Varian Interface Settings	69
8.5.1	Varian 4DTC Interface	70
8.6	Elekta Interface Settings	72
8.6.1	Elekta Interface	72
8.6.2	MOSAIQ Interface	73
8.6.3	XVI Database Interface	74
8.7	Remote Control Settings	74

Table of Contents

9	Backup	.75
10	System Specifications	.76
10.1	Protura Specification	.76
10.2	Power Supply Specifications	.76
10.3	Cable Specifications	.76
10.4	Test/Emission Specifications	.77
11	System Maintenance	.78
11.1	Touchscreen Configuration	.78
11.2	Quality Assurance Test Procedure	.78
11.2.1	Mechanical Maintenance	.78
11.2.2	Isocenter Alignment	.79
11.2.3	Localization Accuracy	.79
11.3	Reprocessing	.80
11.4	Maintenance	.80
12	System Messages	.81

1 Protura™

WARNING



Validated Protura Configurations	Safe Working Load
Varian Exact Base	372 lbs. (169 kg) Universal Couchtop™ One Piece
Protura robot	359 lbs. (163 kg) Universal Couchtop™ Long Extension
Universal Couchtop	<i>Uniformly distributed</i>
Protura robot	440 lbs. (200 kg)
	<i>Uniformly distributed</i>

- Refer to accompanying document, *Protura 1.7.4 Errata*, for Validated Interface information.

INTENDED USE / INDICATIONS FOR USE

The Protura Couch is intended to support and aid in positioning a patient during radiologic, radiation therapy, and other medical procedures. The Protura Couch adds Pitch and Roll to the normal X, Y, Z and Yaw motions. The additional Pitch and Roll make patient alignment simpler without the need to manually move the patient on the table.

The Protura Couch Software is intended to interface between record and verify systems, linear accelerator (Linac) software systems, Linac safeguard systems, and/or image guidance systems and the Protura Couch. The Protura Couch Software is also capable of operating the Protura Couch (6 Degree Axis Couch).

The Protura Couch is suitable for use in Radiation Oncology Treatment vaults.

The Protura Robotic Couch System is comprised of a robotic couch, a software package to control the motion of Protura, and an alignment fixture to assure the software calculates where isocenter is with respect to Protura.

Protura enables the facility to deliver robotic corrections for treatments such as 3D Conformal, IMRT, SRS or SBRT. Available interfaces include patient demographics, Linac Pedestal Location, IGRT move capture, and Remote Control. Protura software stores shift data for each patient which can be printed or exported in PDF format.

Acceptance testing and regular QA is strongly encouraged to assure the product is performing to specifications.

WARNING

- *Federal (United States) law restricts this device to sale by or on the order of a physician.*
- *Prior to use, read and understand all warnings.*
- *Prior to use, review TG40¹, TG53², TG142³ and other pertinent radiation therapy treatment standards and incorporate those methods into your clinical practice to ensure accurate treatments and expected results.*
- *Before use, you should be a trained radiation oncology medical professional.*
- *This product is intended for trained users of the Protura system. This product should not be used without a thorough understanding of the general practice and guidelines regarding IGRT and 6DOF robotic treatment delivery. Personnel should receive training prior to unsupervised operation of the system. For more information, contact Customer Support or your local distributor.*
- *Do not operate Protura if device appears damaged. If problems exist, contact Customer Support or your local distributor immediately.*
- *Protura software must be launched and running to enable all safety measures or precautions.*
- *Ensure Protura is in a position suitable for treatment prior to initiating treatment of a patient.*
- *When operating Protura from outside of treatment room, camera systems should be utilized to visually assure patient safety.*
- *All values imported from another system should be verified for accuracy.*
- *Use of this equipment adjacent to or stacked with other equipment should be avoided because it could result in improper operation. If such use is necessary, this equipment and the other equipment should be observed to verify that they are operating normally.*
- *Use of accessories, transducers and cables other than those provided by the manufacturer of this equipment could result in increased electromagnetic emissions or decreased electromagnetic immunity of this equipment and result in improper operation.*
- *Portable RF communications equipment (including peripherals such as antenna cables and external antennas) should be used no closer than 30 cm (12 in.) to any part of the Protura couch, including cables specified by the manufacturer. Otherwise, degradation of the performance of this equipment could result.*

The user is responsible for ensuring the application and use of the Protura does not compromise the patient contact rating of any equipment used in the vicinity of, or in conjunction with, the system.

The use of accessory equipment and/or hardware not complying with the equivalent product safety and EMC requirements of this product may lead to a reduced level of safety and/or EMC performance of the resulting system. Consideration relating to the choice of accessory equipment used with this product shall include:

- The use of the accessory in the patient vicinity.
- Evidence the safety certification of the accessory has been performed in accordance with the appropriate IEC 60601-1 and/or IEC 60601-1-1 Harmonized National Standards
- Evidence the EMC certification of the accessory has been performed in accordance to the IEC 60601-1-2 Harmonized National Standards.
- The original language of this instruction is English.

For information regarding device accessories, please visit WWW.CIVCORT.COM:

- Protura Alignment Fixture (MT6X-CALS), Universal Couchtop™ (MTIL6040, MTIL6041, MTIL6240).

¹Comprehensive QA for radiation oncology: Report of AAPM Radiation Therapy Committee Task Group 40. Medical Physics 21(4), 1994.

²American Association of Physicists in Medicine Radiation Therapy Committee Task Group 53: Quality assurance for clinical radiotherapy treatment planning. Medical Physics 25(10), 1998.

³Task Group 142 report: Quality assurance of medical accelerators. Medical Physics 36(9), September 2009.

NOTE

Observe all safety precautions recommended by the accessory equipment manufacturer in the user documentation provided with the equipment.

Keep this manual with Protura for quick reference as required.

If any serious incident occurs in relation to device, incident should be reported to manufacturer. If incident occurred within the European Union, also report to the competent authority of the Member State in which you are established.

NOTE

The emissions characteristics of this equipment make it suitable for use in industrial areas and hospitals (CISPR 11 class A). If it used in a residential environment (for which CISPR 11 class B is normally required) this equipment might not offer adequate protection to radio-frequency communication services. The user might need to take mitigation measures, such as relocating or re-orienting the equipment.

In the event of an electro-magnetic disturbance, the Protura Robotic Couch system will not experience uncontrolled movement (translation and rotational movements) or damage, however a disturbance may require the Protura hardware to be rebooted if it is unresponsive.

2 Getting Started

2.1 Hardware Overview



I. Buttons

I

On button (Green):

Turns system on. The light will be lit if the system has power applied. When the On button is pressed, it will light up and Protura will begin to reboot. Once Protura is ready to use, the green LED will light up. The system takes approximately 25 seconds to reboot. Protura will need to be initialized prior to use.

O

Off / STOP button:

Turns Protura hardware off. This can be used to stop Protura in case of an emergency.



Load / Unload button:

Moves Protura to the **Load / Unload** position to make it easier for patients to get on and off the couch pedestal. Load position height is 5cm below the **Zero position**. **Load / Unload** button must be held for one second to activate the move and prevent an unintentional move.



Zero Position button (Blue):

Moves Protura to **Zero Position**. When in **Zero Position**, Protura can be calibrated and given direct commands to move based on IGRT results. **Zero Position** button must be held for one second to activate the move and prevent an unintentional move. This button can also be used to initialize Protura. When Protura is in **Zero Position**, this button will be lit blue.

WARNING



- Use **Off / STOP** button to stop Protura in case of emergency.
- Power **Off / STOP** button turns Protura hardware off, not the power supply.
- Take care to avoid pushing **Load / Unload** or **Zero Position** button unintentionally.

NOTE

When system is first turned on, Protura must go to **Zero Position** before going to **Load / Unload**.

In the **Load / Unload** position, Protura must return to **Zero Position** before initiating patient movements.

When emergency stop is configured, the system emergency stop will stop Protura once activated.

II. Lights

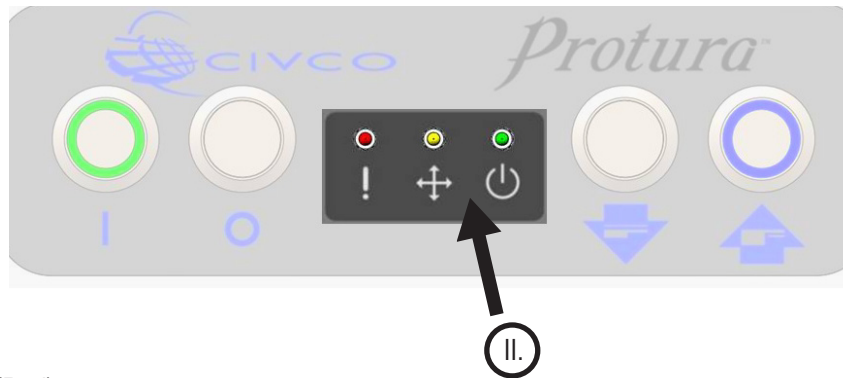

Error light (Red):

Indicates system error. User should examine Protura software for more specific indications of error code being received. If light is on while patient is on the couch, move Protura to **Zero Position** and then to **Load / Unload** position. If Protura does not respond, press **Off / STOP button** to turn off and press **On button** to reboot. If the light comes back on after Protura has rebooted, contact Customer Support or your local distributor immediately.



Motion light (Yellow):

Indicates Protura is in motion.



Ready light (Green):

Indicates Protura system has booted properly and is ready to accept commands. It is possible for the On button to be on but the Ready light to be off.

WARNING



- Do not operate Protura in the event of software warnings or rear panel Error light is lit to indicate a system error.

2.1.1 Range of Motion

Protura software controls the Protura Robotic Couch system. This software/hardware combination allows for highly-accurate patient positioning for targeted treatment.

Prior to using Protura, the system must be configured for use. Start by accessing the **System Settings** window (*refer to Section 8.1 System Settings*).

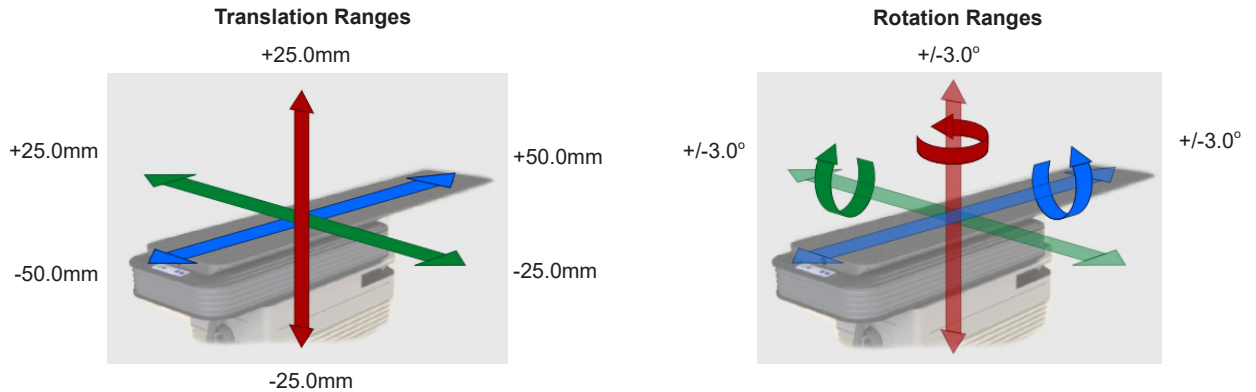

NOTE

Protura software limits rotational shifts to 5 degrees. Protura hardware may limit rotational shifts to 3 degrees or less based on pivot point location and magnitude of other shifts. Prior to executing move, Protura will notify user if proposed move request exceeds limits.

WARNING



- Take care when moving Protura or linac gantry to ensure patient and system collisions are avoided.
- Take care when moving Protura to ensure patient is immobilized as necessary.

2.2 Software Overview

Main Menu Window. The Protura application main window includes:

- I. Main Menu Bar
- II. Patient Data Panel
- III. Couch Position Panel
- IV. Couch Button Panel
- V. Status Area



NOTE Every window in Protura allowing motion provides a **STOP** button. Be prepared to activate this during motion, if necessary.

I. Main Menu Bar

Additional functionality is accessed in the Main Menu Bar. Options appear grey when unavailable or action is already achieved.



File: Contains the ability to create new patient record, open patient record, close a currently loaded patient record, delete patient record, import patient record and exit program.

Tools: Allows user to configure system, import configuration, export configuration, run a test procedure, align the pedestal, or override an IGRT setting.

Reports: Generates patient reports.

Help: Provides Protura information.

II. Patient Data Panel



MR: 1234567890-001
Name: Smith, Michael Edit Patient
Add Course: Tonsil Field: 1
Move Speed: Low IGRT: Default (default)

- **MR:** Displays patient's MR information. For MR entries exceeding 64 characters in length, the system will display an ellipsis (...) to indicate the data has been truncated.
- **Name:** Displays patient's name. (*Last Name, First Name*) For patient names exceeding 30 characters in length, the system will display an ellipsis (...) to indicate the data has been truncated.
- **Edit Patient button:** Refer to Section 5.1.3 *Edit Patient Record*.
- **Add button:** Adds a course or field.
- **Course:** Course data is stored with patient data and available when patient is loaded. Refer to Section 5.1.4 *Define Course Identifiers*.
- **Field:** Field Identifier. *This field accepts up to 30 characters.* Field data is not stored with patient data. The value entered here is written to the Move Report only (refer to Section 7.1 *Daily Move Report* and Section 7.2 *Patient Move Report*).
- **Move Speed:** Displays move speed of the currently-loaded patient. (*Low, Medium and High*)
- **IGRT:** Refer to Section 8.3 *IGRT Coordinate System Configuration*.

III. Couch Position Panel

This panel contains four distinct sections:

- **Keypad** is accessible using a computer mouse or touch screen keys for changing field focus and adjusting field values. Use the **Import** button to import patient information and IGRT data.
- **Current Couch Pedestal Location** is used to capture current coordinates and rotation of the couch pedestal. Locking the pedestal values sets the pivot point at isocenter in preparation for IGRT adjustments.
- **Proposed Values** is used to enter IGRT target coordinates. Colored text (*shown in green in image below*) serves as an indicator for displayed values.
 - **White text:** Displayed values are unchecked.
 - **Green text:** Displayed values are possible with the hardware.
 - **Red text:** Displayed values are NOT possible with the hardware. Select the **Reduced Shift** button or the **Move** button to view potential values.
- **Current Values** displays current Protura position. Current Values may not exactly match Proposed Values due to angle order and pedestal rotation corrections.
 - **0.00 Values:** Displayed prior to initiating motion.
 - **Current Relative Positions:** Displayed following successful motion.
 - **Red Double Dashes:** Displayed when the current position of the couch is unknown. (*i.e., Couch stops prior to reaching the set position*).

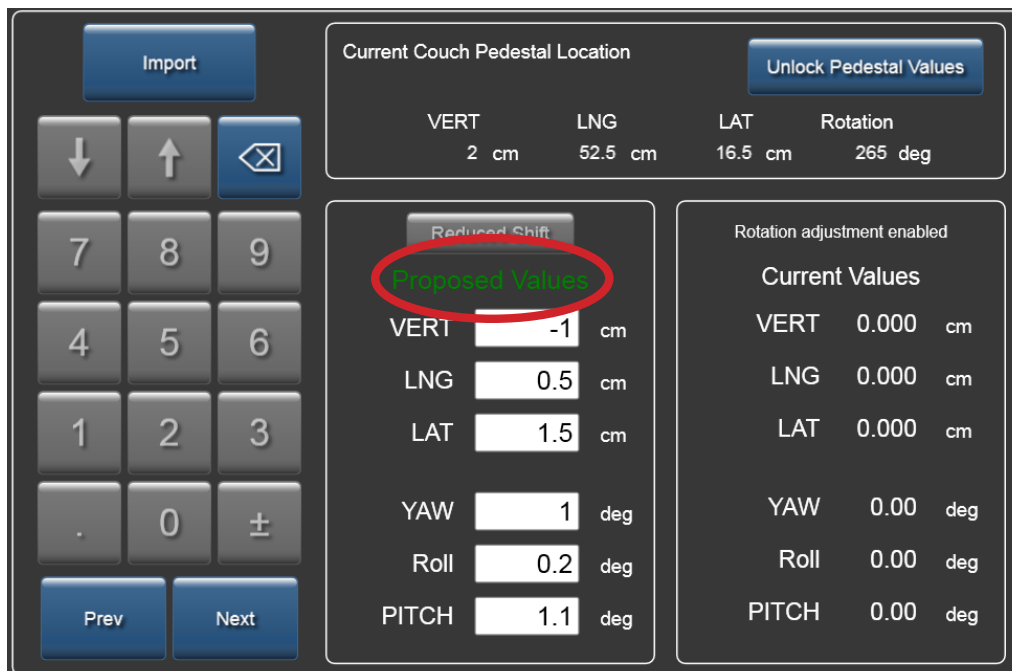

IV. Couch Button Panel

This panel contains buttons to trigger couch movement.

- **Load / Unload button:** Moves Protura to the **Load / Unload** position to make it easier for patients to get on and off the couchtop. Load position height is 5cm below **Zero Position**. When in **Load / Unload** position, Protura must return to **Zero Position** before initiating motion.
- **Zero Position button:** Brings couch to the **Zero Position**. When in **Zero Position**, the couchtop can be aligned and Current Couch Pedestal Location can be locked prior to giving direct commands to move based on IGRT results.
- **Move button:** Initiates motion based on IGRT results.
- **STOP button:** Ceases Protura motion.

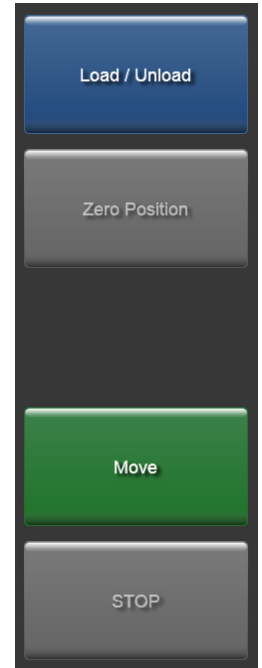

V. Status Area

Located at the bottom of the main window.

- **Message Bar:** Indicates Protura movement status.

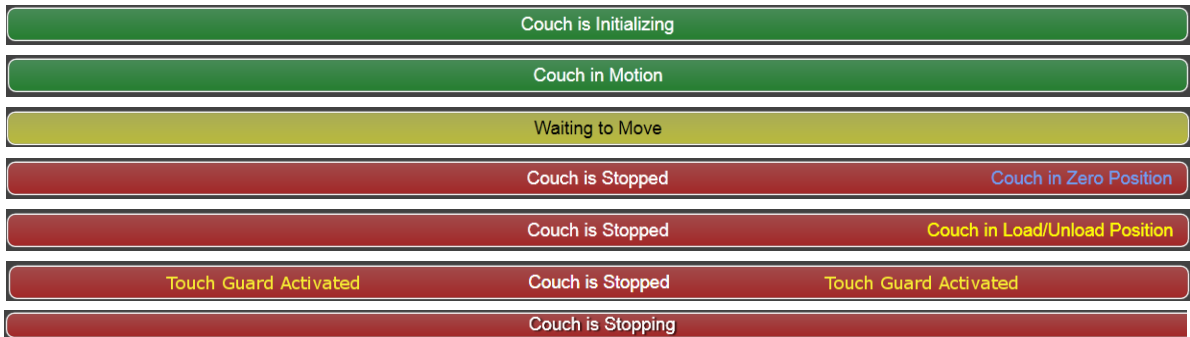

- **Status Bar:**



- IGRT System: Data type (Offset or Absolute) and Pedestal Rotation Compensation, PRC when active (*refer to Section 8.3 IGRT Coordinate System Configuration*).
- Protura Version information.
- Couch Pedestal Alignment date.
- Linac connection status, if applicable.



- Protura hardware connection status.
- Remote Control connection status, if applicable.



3 Alignment

3.1 Alignment Fixture

1. Unfold fixture.

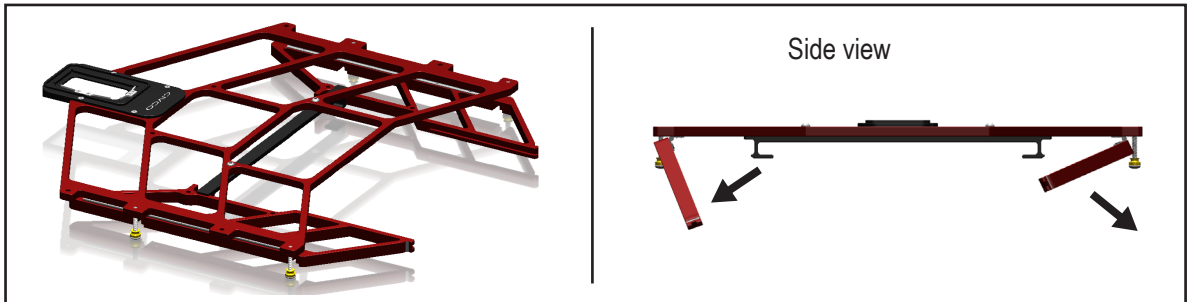

2. Tighten thumb nuts.

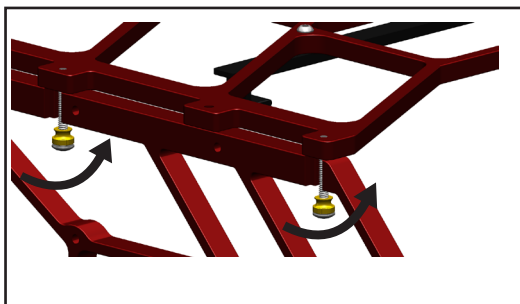

3. Place alignment block.

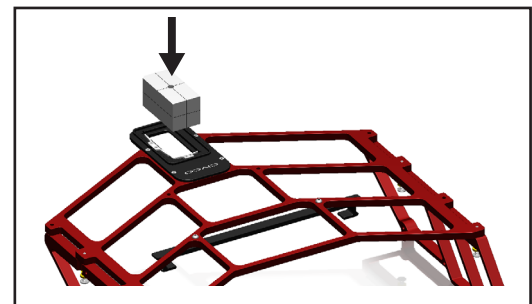

4. Install onto Protura, slide under receiving bracket and align on pins.

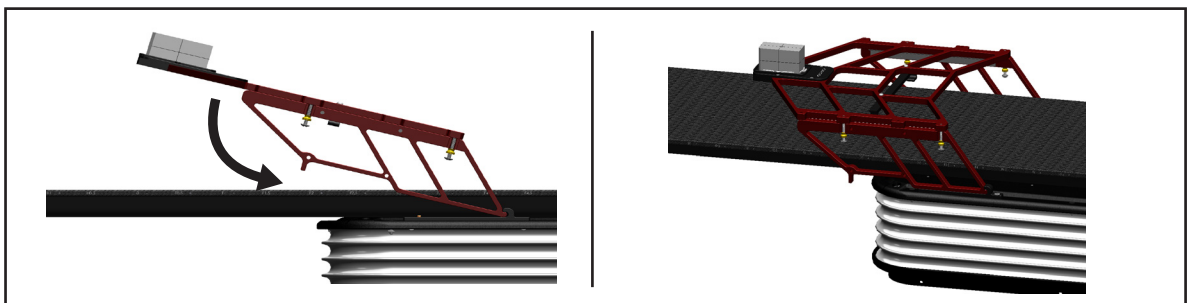

5. Ensure alignment fixture is properly seated on both sides and white is not visible at the junction of mount point on alignment fixture prior to performing alignment.

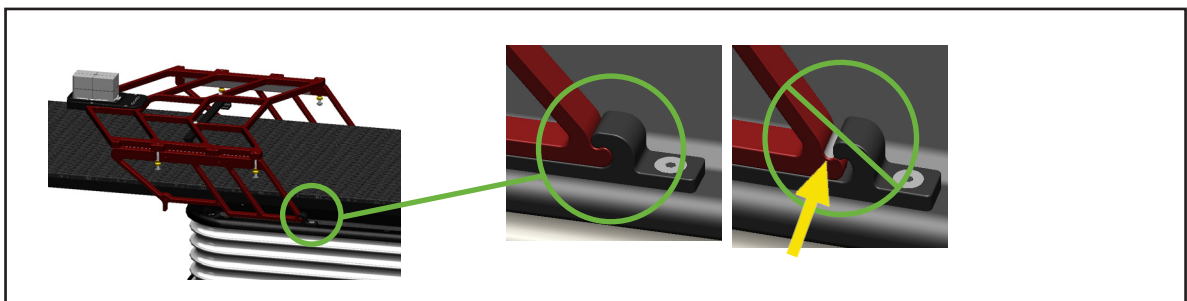

3.2 Isocenter Alignment

The Protura system features a virtual pivot point. Any corrections to the couch position (*including pitch, yaw and roll*) are executed with the isocenter as the virtual pivot / reference point.

To set the virtual pivot point, Protura hardware must know where the isocenter is in relation to its own pivot point.

WARNING



- *Protura alignment assures the virtual pivot point will be calculated properly with respect to the linac isocenter. Failure to assure there has been no drift over time can lead to inaccurate shifts and potential mistreatment. Since there are no clear AAPM recommendations for couch pedestal to isocenter QA measurements, the user is advised to routinely perform Protura alignment until the stability is assessed over time.*

NOTE

CIVCO strongly recommends the user calibrate their laser system prior to performing this procedure with Protura.

1. From the **Tools** menu, click **Align Pedestal**. This menu option is not available if a patient file is open.

Enter Password window displays. There are two methods to enter password.

- Enter password (*default password is **CeePro**, refer to Section 8.1 System Settings*). Click **OK**. To leave Enter Password window without making changes, click **Cancel**.

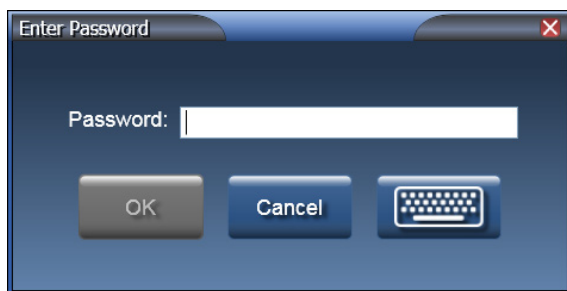

- Click the keyboard icon. Enter password using a mouse or touch screen (*default password is **CeePro**, refer to Section 8.1 System Settings*). Click **OK**.



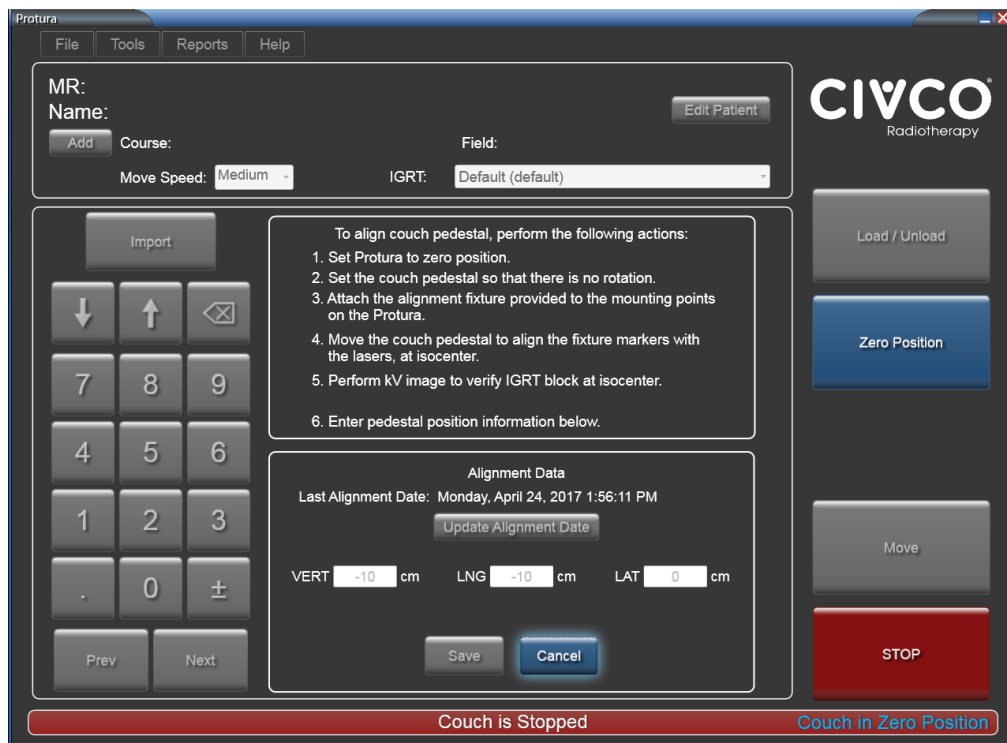

2. Follow instructions on screen:
 1. Click **Zero Position**.
 2. Set couch pedestal so there is no rotation.
 3. Attach alignment fixture (*refer to Section 3.1 Alignment Fixture*).
 4. Adjust pedestal (*NOT Protura*) so the IGRT block at the end of the fixture is aligned to room lasers or light field.
 5. Perform kV image to verify IGRT block at isocenter.
 6. Record pedestal position values in millimeters or centimeters (*as defined in Section 8.2 Couch Pedestal Configuration*) into Protura alignment window. The location of the pedestal will be used from now on to calculate the virtual pivot point location.
3. Click **Update Alignment Date** to update alignment date if the new calibration has the same values as the previous alignment.
4. Click **Save**.
5. Exit and re-launch the Protura software.

4 Test Procedure

Test Procedure moves Protura hardware in 6DOF to test range of motion. The Test Procedure uses Protura Default Speed (refer to Section 8.1 System Settings). Test Procedure may take several minutes to complete.

Prior to conducting Test Procedure:

- Ensure the Protura is in a safe position.
- Ensure patient record is not open.
- Ensure there is no patient on couchtop.

1. From the **Tools** menu, click **Test Procedure....**

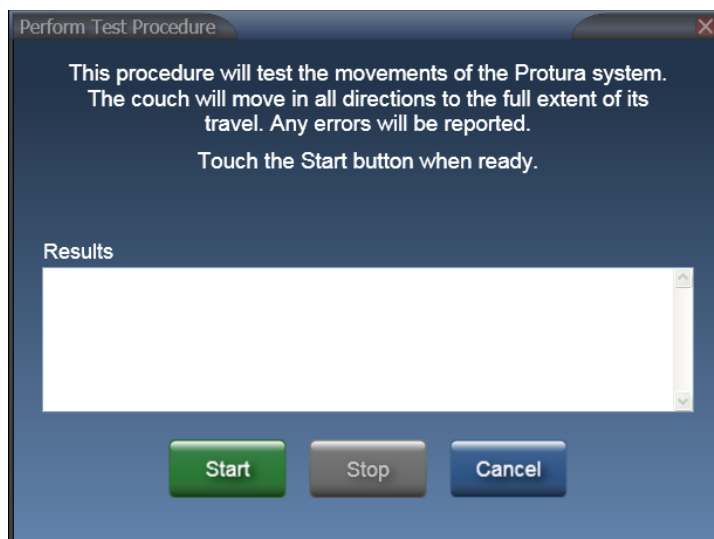

2. Click **Start** to begin Test Procedure. Test Procedure to Begin message box will be displayed.

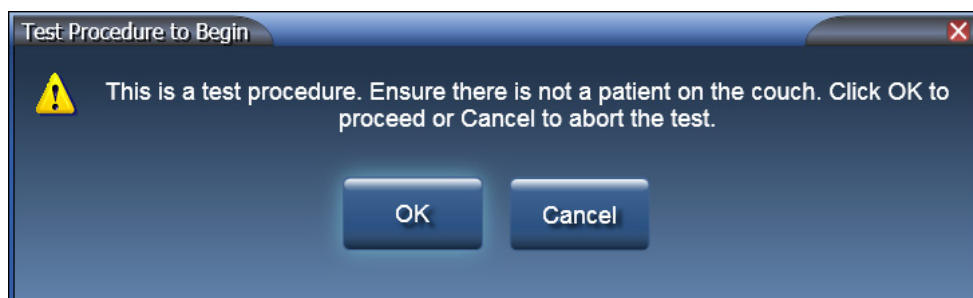

3. Click **OK**. Test Procedure begins.

4 Test Procedure

Test Procedure displays the current action.

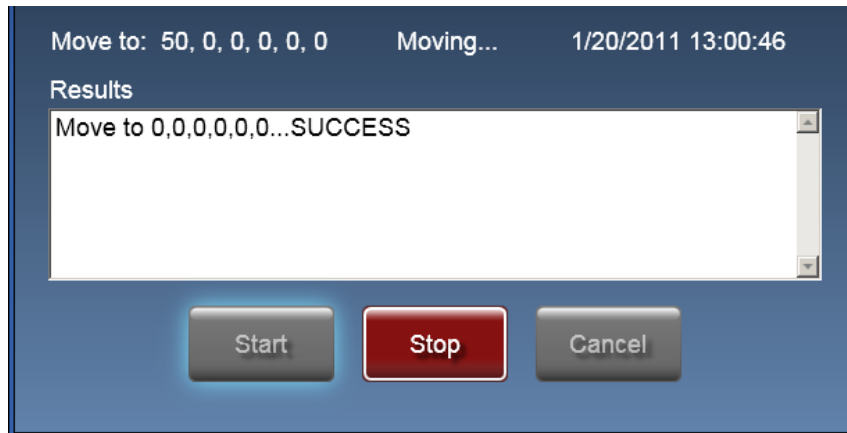

While Test Procedure is in progress, the **Stop** button may be used to stop Protura movement and end Test Procedure.

When **Stop** button is pressed, Protura will pause for 5 seconds. Test Procedure Aborted window will be displayed. Click **OK** to move back to **Zero Position**.



4. Once Test Procedure is complete, results will appear in the **Results** text panel.

NOTE

If Results show an error/failure, click **Start** to return Protura to **Zero Position** and run test procedure again. If Test Procedure continues to fail, contact CIVCO Customer Service.

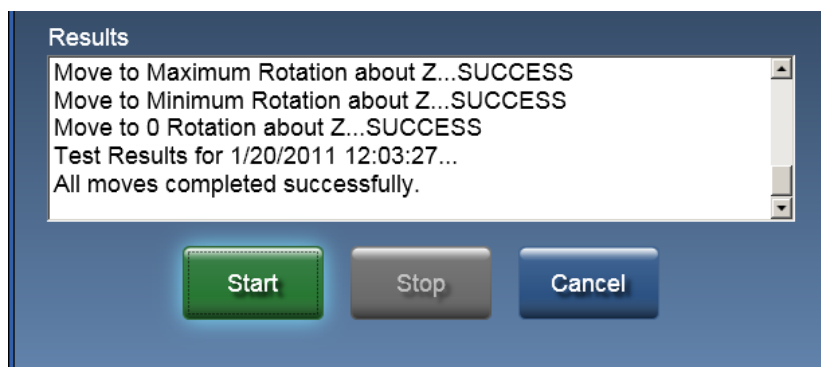

5. To close **Results** window, click **Cancel**.

5 Using Protura

5.1 Managing Patient Information

Patient records can be created in advance of treatment or during import of IGRT data. Read and understand *Sections 2 Getting Started and 3 Alignment* before using Protura.

WARNING



- If pedestal rotation (couch kick) is desired for treatment, be sure to select and verify correct settings for IGRT system. Protura can make corrections to 6DOF information to account for pedestal rotations. However, if IGRT system already takes this into account before providing recommended shifts, correction in Protura is not needed.
- Execution of QA tests is required during Protura installation and IGRT system configuration to assure proper results. Failure to do so can result in patient mistreatment. Always verify shifts through re-imaging and verification and IGRT.
- Protura does not account for patient movement. A confirmation image is recommended to ensure patient and target are in the desired location before treatment is delivered.

5.1.1 Create Patient Record

When creating a patient record, any value entered exceeding the maximum character limit will not be displayed. MR Number, Last Name and First Name are required fields to save the patient record. Once data is saved, a tool tip is available to display.

1. From the **File** menu, click **New Patient...** or select **[Ctrl]+N** on the keyboard.

The screenshot shows a 'New Patient' dialog box with the following elements:

- MR: [Text input field]
- Last Name: [Text input field]
- First Name: [Text input field]
- Course: [Dropdown menu showing 'None selected'] with an 'Add' button to its right.
- Note: Once an MR Number is saved, it cannot be changed.
- Buttons: 'Clear', 'Save', and 'Cancel' at the bottom.

2. Enter **MR Number**. *This field accepts up to 64 characters and is case sensitive.*

NOTE

The MR Number must be unique.

The MR Number cannot be changed once the patient record is saved.

3. Enter patient's **Last Name**. *This field accepts up to 30 characters.*
4. Enter patient's **First Name**. *This field accepts up to 30 characters.*
5. **Course** values are optional (*refer to Section 5.1.4 Define Course Identifiers*).
6. Click **Clear** to clear data from all fields, **Save** to save patient record, or **Cancel** to close the window without saving changes.

5.1.2 Open Patient Record

1. From the **File** menu, click **Open Patient...** or select **[Ctrl]+O** on the keyboard.
2. Click **column heading** to sort patient list. Click **column heading** again to switch from ascending sort to descending sort.

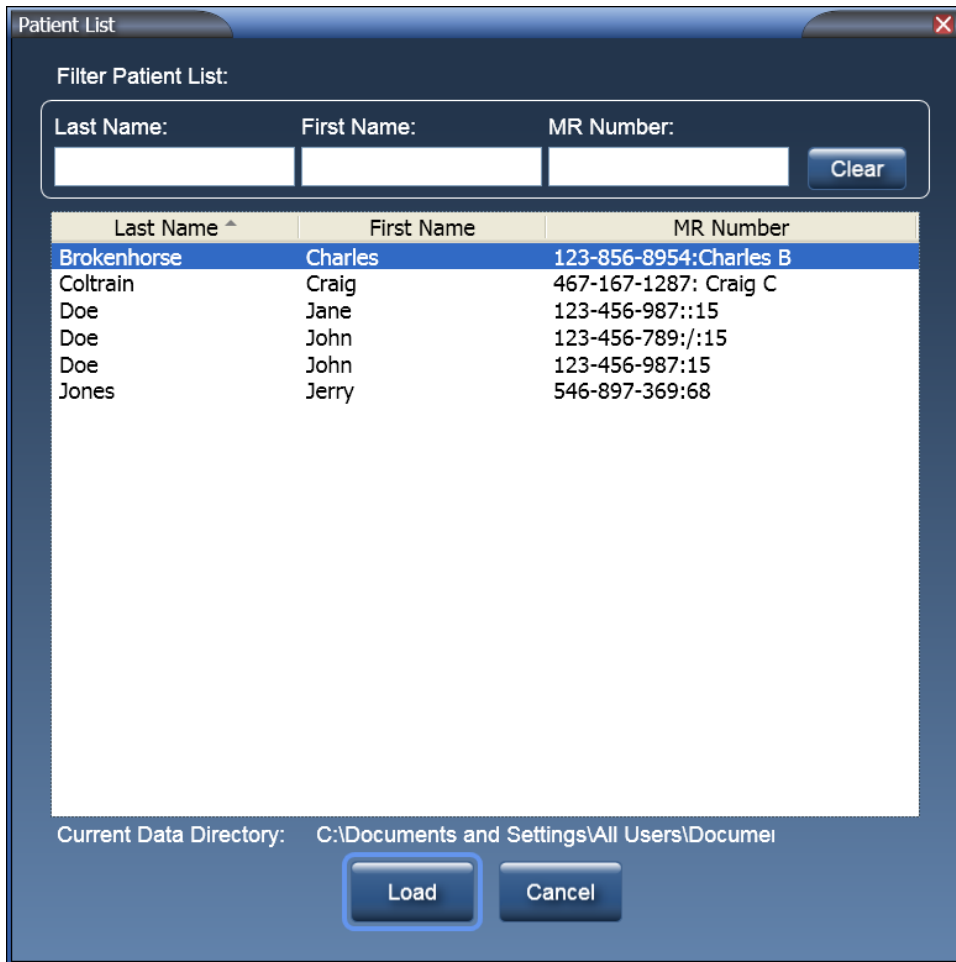

3. **Filter Patient List** text boxes filters patient list to show only those records which contain value entered in corresponding column. The filter text boxes can be used in combination.

For example, entering **do** in **Last Name** text box and **jo** in **First Name** text box, Patient List will filter these records:

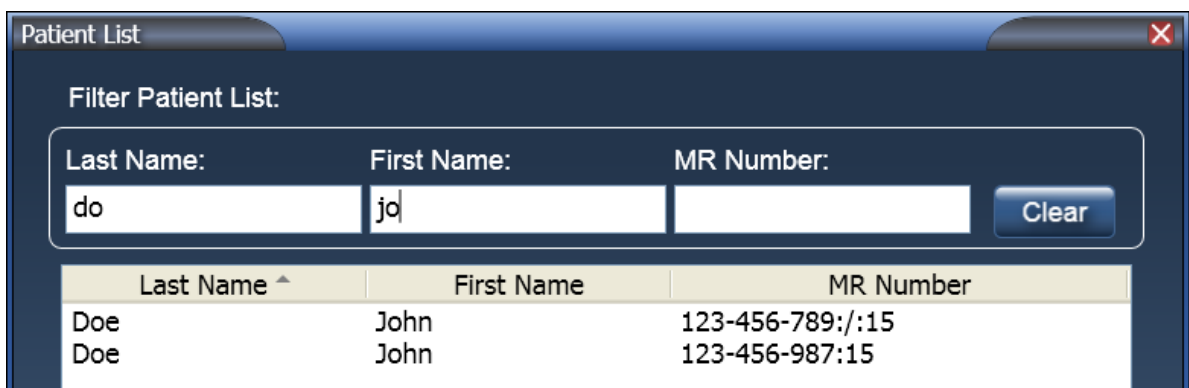

5 Using Protura

4. Select the row of the patient to be opened.
5. Click **Load** or **double-click the patient** to load into Patient Data Panel on the main window or click **Cancel** to close the window without loading a patient.
6. After the patient is loaded, the **Current Couch Pedestal Location** values will be shaded with a red background and values are black. If the patient has been treated before, the last couch positions used will automatically be loaded.

NOTE

If the values are out of range, the **Current Couch Pedestal Location** values will be shaded with a red background and the values will be white until corrected.

Current Couch Pedestal Location

Lock Pedestal Values

VERT	LNG	LAT	Rotation
11.42 cm	149 cm	47 cm	0 deg

7. These values must be confirmed as accurate before pedestal can be locked and movement can begin. Select each field and update the value, if necessary. Click **Lock Pedestal Values**. When values need to be changed, click **Unlock Pedestal Values**.

NOTE

If **Couch Pedestal Configuration** thresholds are exceeded, a warning message will appear (refer to Section 12 System Messages).

5.1.3 Edit Patient Record

1. Select **Edit Patient** from **Patient Data Panel**.

MR: 123-456-789/:15

Name: Doe, John

Add Course: C1 Field: []

Move Speed: Low IGRT: Default (default)

2. Update patient data as necessary.
 - **MR** Number is a fixed field and cannot be edited.
 - Click **Clear** to clear data from all fields.
 - **Course** values are optional (refer to Section 5.1.4 Define Course Identifiers).

NOTE

With Varian interface enabled, **checkbox** is available to indicate if **Patient Treatment Uses Protura**.

Edit Patient

MR: 123-456-789/:15

Last Name: Doe

First Name: John

Course: Course 1 Add

Patient Treatment Uses Protura

Note: Once an MR Number is saved, it cannot be changed.

Clear Save Cancel

3. Click **Save** to save the patient record or click **Cancel** to close the window without saving changes.

5.1.4 Define Course Identifiers

Course identifiers can be defined when adding patient, editing patient, or through the main window after opening a patient.

1. Click **Add**.

The 'New Patient' dialog box contains the following fields: MR (text input), Last Name (text input), First Name (text input), and Course (dropdown menu currently set to 'None selected'). An 'Add' button is located to the right of the Course dropdown and is circled in red. Below the Course field, a note states: 'Note: Once an MR Number is saved, it cannot be changed.' At the bottom of the dialog are 'Clear', 'Save', and 'Cancel' buttons.

The patient data panel displays: MR: 123-456-789:/:15, Name: Doe, John, and an 'Edit Patient' button. Below this, there is an 'Add' button (circled in red), a 'Course' dropdown menu, a 'Field' text input, a 'Move Speed' dropdown menu (set to 'Low'), and an 'IGRT' dropdown menu (set to 'Default (default)').

2. Enter a **Course** value. *This field accepts up to 30 characters and is case sensitive.*

The 'Add New Course' dialog box has a 'New Course' text input field containing the text 'C1'. At the bottom are 'Add' and 'Cancel' buttons.

3. Click **Add** to add Course value to the **Course** drop-down list and close the window or click **Cancel** to close the window without saving changes.

NOTE

A course must be defined and selected to ensure patient setup is not outside of pedestal threshold value. Once a course is added, it cannot be deleted or renamed.

4. Enter a **Field** value (*optional*). Field value will be stored with move data.

5.1.5 Close Patient Record

1. From the **File** menu, click **Close Patient**. The patient data panel is cleared. Selecting **Load / Unload** button will also close patient record if there is no active Remote Control connection.

NOTE

Some application functions cannot be performed while a patient is loaded in the Patient Data Panel. For example, the System Configuration settings cannot be changed until the Patient is closed.

5.1.6 Delete Patient Record

1. From the **File** menu, click **Delete Patient...** or select **[Ctrl]+D** on the keyboard.

Last Name ^	First Name	MR Number
Brokenhorse	Charles	123-856-8954:Charles B
Coltrain	Craig	467-167-1287: Craig C
Doe	Jane	123-456-987::15
Doe	John	123-456-789:/:15
Doe	John	123-456-987:15
Jones	Jerry	546-897-369:68

Click the column heading to sort patient list. Click the column heading again to switch sort from ascending to descending.

Filter Patient List: Filters patient list to show only those records which contain value entered in corresponding column. The filter text boxes can be used in combination. For example, entering **do** in **Last Name** and **jo** in **First Name**, Patient list will filter these records:

Last Name ^	First Name	MR Number
Doe	John	123-456-789:/:15
Doe	John	123-456-987:15

2. Select patient(s) rows to be deleted.

Multiple contiguous rows can be selected by using **[Shift]+click**. Multiple non-contiguous rows can be selected by using **[Ctrl]+click**.

3. Click **Delete** to delete selected patient record(s). A window will display to confirm deletion, click **OK**. Or click **Cancel** to close the window without deleting any patients.

NOTE

Deleting patient record(s) removes all history and recorded data for patients selected and cannot be recovered.

5.2 Patient Moves

Protura is designed to accurately move patient to desired treatment position using IGRT data.

NOTE

In order to be in a position to make corrections, the Protura **MUST** be moved to **Zero Position** BEFORE imaging is performed. Protura is unable to make corrections from the **Load / Unload Position**.

In order to ensure patient does not move during treatment, CIVCO recommends patients be immobilized on couchtop. For more information on immobilization products, please contact your local CIVCO representative.

5.2.1 Change IGRT System

The IGRT system can be changed from within a patient record.

1. In **Patient Data Panel**, select the **IGRT** system from the drop-down menu.



5.2.2 Change Move Speed

Current **Move Speed** can be overridden for a patient on a per-patient and per-treatment basis (*refer to Section 8.1 System Settings*).

The overridden **Move Speed** value is stored with each patient move. When the patient is reloaded, the most recent **Move Speed** value is used.

In Patient Data Panel, select desired **Move Speed** from drop-down list. The **Move Speed** values are Low, Medium and High.

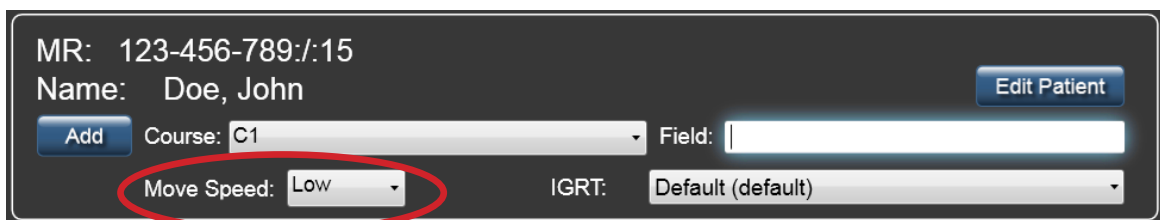

NOTE

Patients may react differently to the various speeds, work with your patient to select appropriate and comfortable speed. Increased **Move Speed** may require more rigid immobilization, both for comfort as well as for assuring the patient is not moved inadvertently.

5.2.3 Couch Pedestal Location

1. Enter **Current Couch Pedestal Location** values.

Current Couch Pedestal Location Lock Pedestal Values

VERT	LNG	LAT	Rotation
20 cm	150 cm	0.2 cm	0 deg

A warning message will appear if values entered into **Current Couch Pedestal Location** exceed defaults set for thresholds in **Couch Pedestal Configuration** tab from the patient's last move for the selected Course. Click **Yes** to proceed with current values.

2. Click **Lock Pedestal Values** button.

Current Couch Pedestal Location Lock Pedestal Values

VERT	LNG	LAT	Rotation
20 cm	150 cm	0.2 cm	0 deg

3. When Pedestal Values are locked, the **Move** button becomes active.

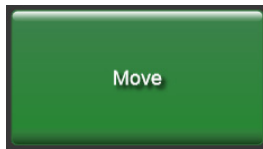

5.2.4 Move Patient - Proposed Values

The **Proposed Values** section allows user to enter desired 6DOF adjustments for a patient move with Protura.

1. Import or manually enter corrections into **Proposed Values**. *Default values are zero.* Changes will be displayed in **Current Values**.

Import Current Couch Pedestal Location Unlock Pedestal Values

VERT	LNG	LAT	Rotation
2 cm	52.5 cm	16.5 cm	265 deg

Reduced Shift

Proposed Values

VERT	LNG	LAT	YAW	Roll	PITCH
0 cm	0 cm	0 cm	0 deg	0 deg	0 deg

Rotation adjustment enabled

Current Values

VERT	LNG	LAT	YAW	ROLL	PITCH
0.000 cm	0.000 cm	0.000 cm	0.00 deg	0.00 deg	0.00 deg

5 Using Protura

- Use **Prev** or **Next** to move focus to the first **Proposed Values** field or select field directly with mouse or by touching field on touch screen display.
- Enter target values with on-screen number pad or keyboard.

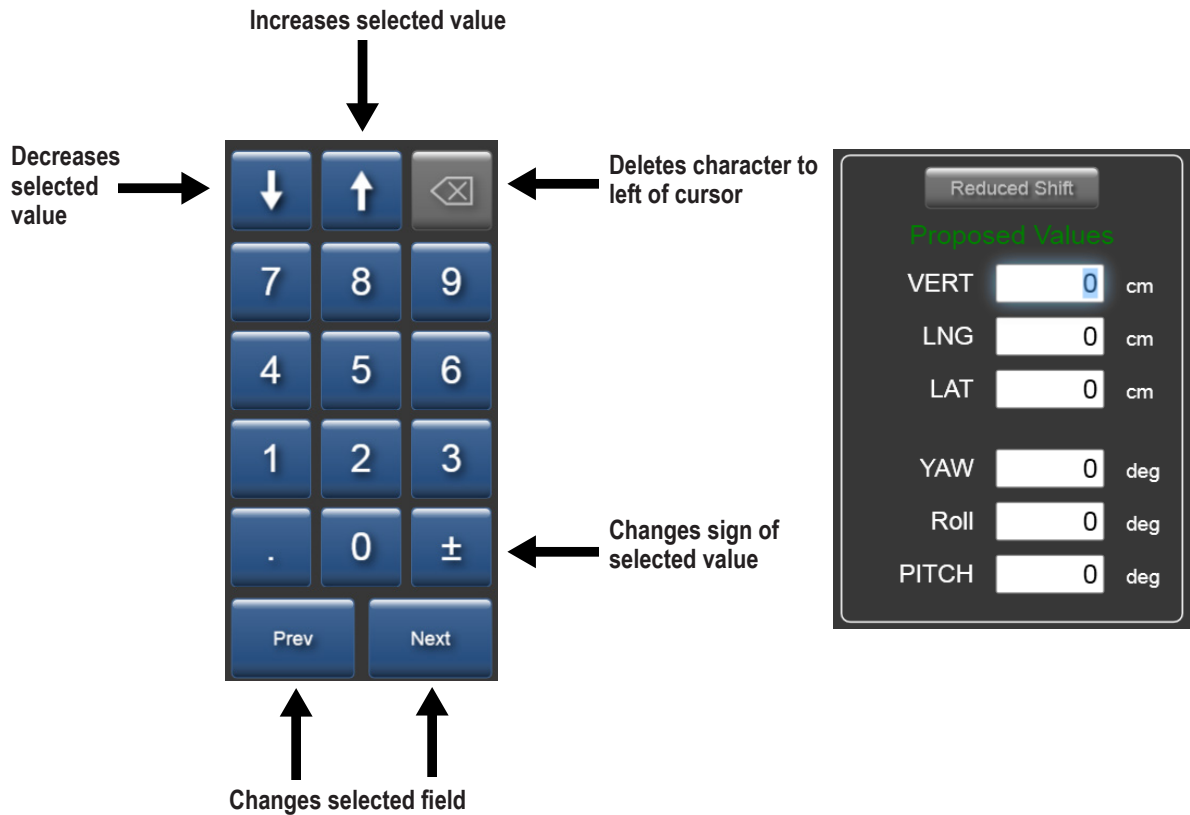

- Click **Move**.

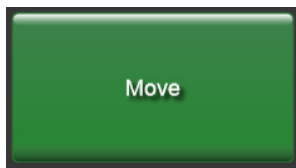

WARNING



- When a relative move is interrupted, the **Proposed Values** do not reflect the remaining move position. Users must confirm the patient is in the correct position prior to starting treatment.

5.2.5 Move Out of Range

Protura will determine if coordinates defined in **Proposed Values** are reachable based on current Protura and pedestal position.

If **Proposed Values** are not reachable but can be made with a set of reduced values, a message is displayed offering the option to use those reduced values or reposition the patient. Select the appropriate button based on desired outcome.

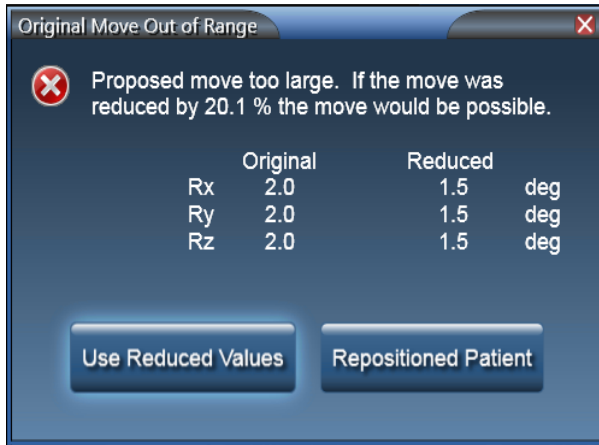

If **Proposed Values** are too large and cannot be made, a message is displayed indicating the patient needs to be repositioned and new IGRT coordinates calculated. Select the **Repositioned Patient** button after patient has been moved.



5.2.6 Move Successful

A confirmation message will be displayed at the completion of each successful move.

1. **Move Successful** message window will be displayed. Click **Yes** if patient is ready for treatment. Click **No** to return to **Current Couch Pedestal Location** panel to make additional adjustments.

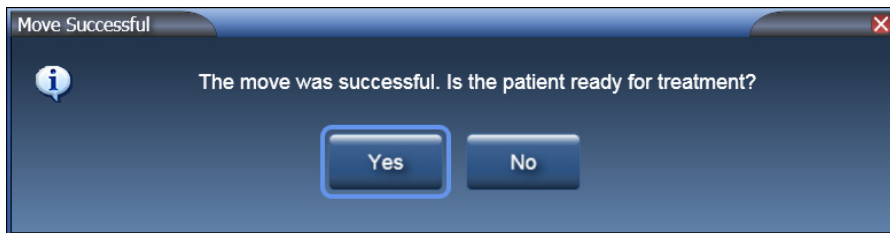

2. If **Yes** is selected, **Ready for Treatment** message window will be displayed and Protura is locked for treatment.

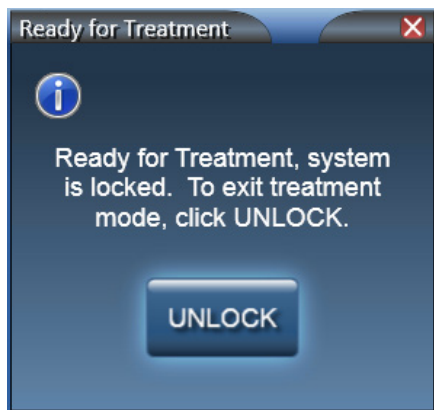

3. When treatment delivery is complete, click **UNLOCK**.

6 Protura Workflows

6.1 General Protura Workflow

This section details workflow for general positioning for treatment without linac integration.

WARNING



- When the pedestal is moved from the locked position prior to a secondary Protura rotation, a confirmation image is required after the secondary Protura rotation to verify any residual error is within treatment tolerance.

1. With Protura in **Load / Unload** position, open patient in Protura system.
2. Filter Patient List by First Name, Last Name and/or MR Number and select patient record. Click **Load**.
3. Escort patient into treatment room and immobilize patient on couchtop as defined in treatment plan.
4. Move Protura to **Zero Position**.

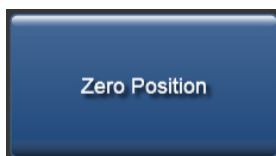

5. Move pedestal into treatment position using laser marking system, noting pedestal X Y Z coordinates.
6. Select each field of **Current Couch Pedestal Location** screen to enter coordinate value or to confirm displayed value from previous treatment.
7. Select **Lock Pedestal Values** to confirm pedestal coordinate values.

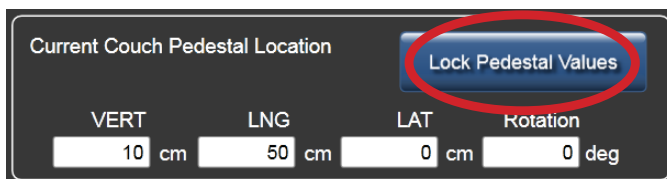

8. Exit treatment room.
9. Use IGRT system to calculate necessary shifts to place target at desired location. Enter values into Protura.

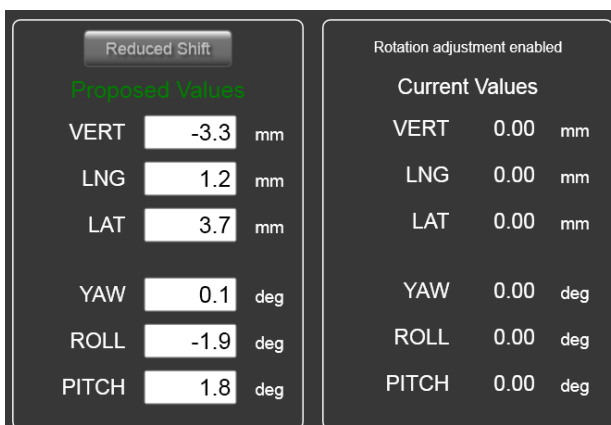

WARNING



- Prior to selecting the Move button, verify pedestal and shift values in Protura match the IGRT system values.

10. Click **Move** button to move Protura into treatment position.

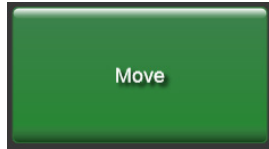

11. **Move Successful** message will be displayed. Click **Yes** to lock Protura for treatment.

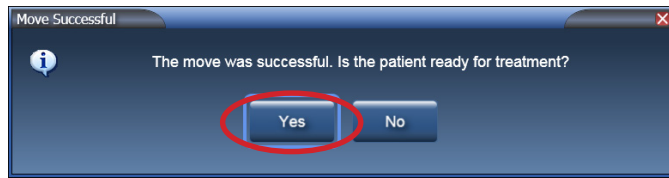

NOTE

A confirmation image is recommended to ensure patient and target are in the desired location before treatment is delivered.

12. **Ready for Treatment** message will be displayed. System is now locked and ready for treatment.

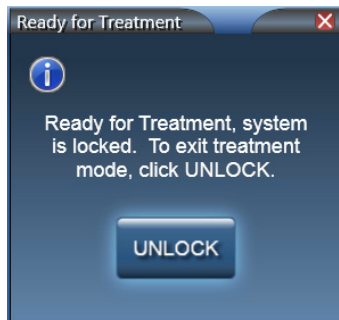

13. Follow protocol for treatment delivery.

14. Upon completion of treatment at current isocenter location, enter treatment room.

15. Select **UNLOCK** in Protura software.

16. For treatment delivery at multiple isocenter locations on current patient:

1. Move Protura to Zero Position.

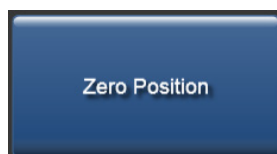

2. Select Unlock Pedestal Values.

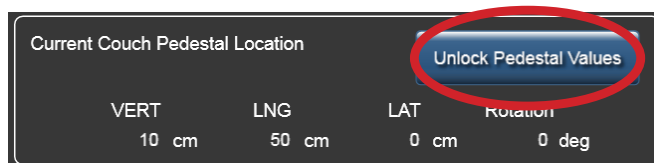

3. Repeat workflow beginning with step 5.

6 Protura Workflows

17. When treatment is complete, select **Load / Unload** button. Protura will move to **Load / Unload** position and automatically close patient record.

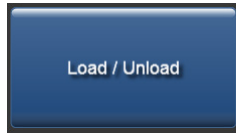

18. Patient may exit treatment room.
19. Generate **Patient Move Report** in Protura software at completion of treatment. Save report in patient file as defined in site protocol. Reports can be automatically generated upon closing of patient record and stored in defined directory location. Refer to Section 7.2 Patient Move Report and Section 8.1 System Settings.

6.2 Protura Workflow - Varian Integration without Pedestal Shifts

This section details workflow with Varian integration and 6DOF with Protura. In the Varian Interface tab, **Division of Movement** must be set to **All 6 degrees Protura**. Refer to Section 8.5 Varian Interface Settings.

WARNING



- Execution of QA tests is required following any updates to Varian 4DTC, OBI, ARIA, or MOSAIQ systems. Verify shift values calculated by Protura match the shifts generated in the OBI System.
- When making Protura shifts with Varian interface enabled, do not Apply Shifts to pedestal with the OBI System or other non-Protura systems. Protura will not update with new pedestal location, thus rotations will not occur at room isocenter and double shifts are possible.
- Ensure patient record in Varian 4DTC System matches patient record in Protura.
- Treatment authorization to Varian 4DTC System will remain active until Clear Mode Up is selected.

1. With Protura in **Load / Unload** position, **open** patient in **Varian 4DTC System** or **MOSAIQ**.
 - If selected patient exists in Protura database, patient record will automatically launch in Protura.
 - If selected patient does not exist in Protura database, **New Patient** message will be displayed. Click **Yes** to indicate patient will be treated using Protura. Patient record will be added to Protura and will automatically launch.

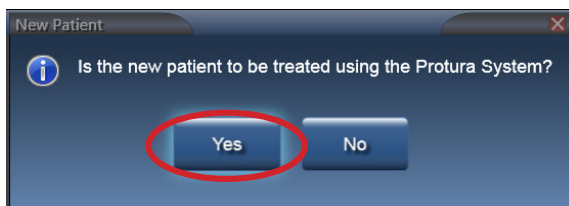

NOTE

If patient is not treated with Protura, refer to Section 6.4 Protura Workflow - Varian Integration without Protura.

2. In **Varian 4DTC System**, **Mode Up** the setup field.
3. Escort patient into treatment room and immobilize patient on couchtop as defined in treatment plan.
4. Move Protura to **Zero Position**.

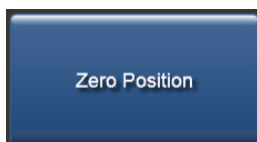

6 Protura Workflows

5. Align patient to external markers.
6. Exit treatment room.
7. Calculate shifts with **OBI System** to align target.
8. In **OBI System**, click **Save Match** and shift values are saved.

Couch Position (VAR IEC Scale, All units in cm and degrees) and Shift								
Raw Shift Values				Machine Values				Reset Shift
	SHIFT		SHIFT	TARGET	ACTUAL	SHIFT		
Couch Vrt	-0.5	Couch Pitch	-1.0	Couch Vrt	12.0	12.5	-0.5 <input checked="" type="checkbox"/> Include	
Couch Lng	+0.4	Couch Roll	+0.5	Couch Lng	140.4	140.0	+0.4 <input checked="" type="checkbox"/> Include	
Couch Lat	+0.3	Couch Rtn	-0.9	Couch Lat	0.3	0.0	+0.3 <input checked="" type="checkbox"/> Include	
		Couch Proj Rtn		Couch Rtn	359.1	0.0	-0.9 <input checked="" type="checkbox"/> Include	
							Save Match	
							Apply Shift	

NOTE

Protura software calculates shift values, gets pedestal location from the Varian 4DTC System (with a pedestal 0,0,0 move request), and locks the pedestal in Protura software.

9. Protura displays shift values and **Move** button becomes available.

WARNING



- Prior to selecting the **Move** button, verify pedestal and shift values in Protura match the IGRT system values.

10. Click **Move** button to move Protura into treatment position.

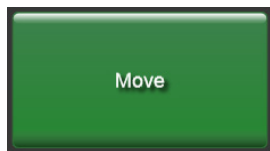

11. **Move Successful** message will be displayed in Protura system. Click **Yes** to lock Protura for treatment.

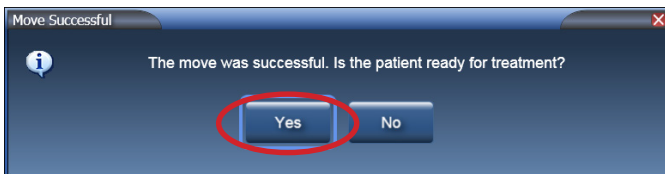

NOTE

A confirmation image is recommended to ensure patient and target are in the desired location before treatment is delivered.

12. **Ready to Authorize** message will be displayed. System is now locked and ready for treatment.

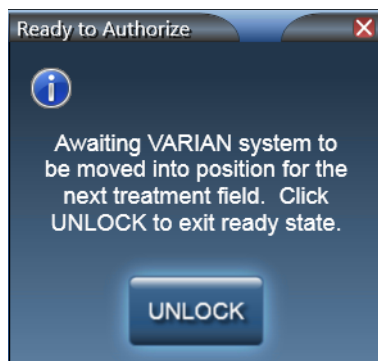

13. In **OBI System**, click **Cancel** and select **No** to apply shifts.

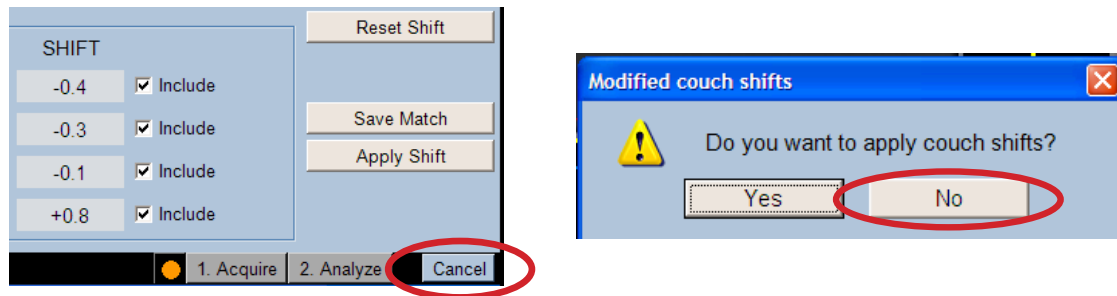

14. In **Varian 4DTC System**, click **Cancel** to pedestal move request 0,0,0, which is sent from Protura to access pedestal location. Select **Yes** to cancel pedestal shift request.

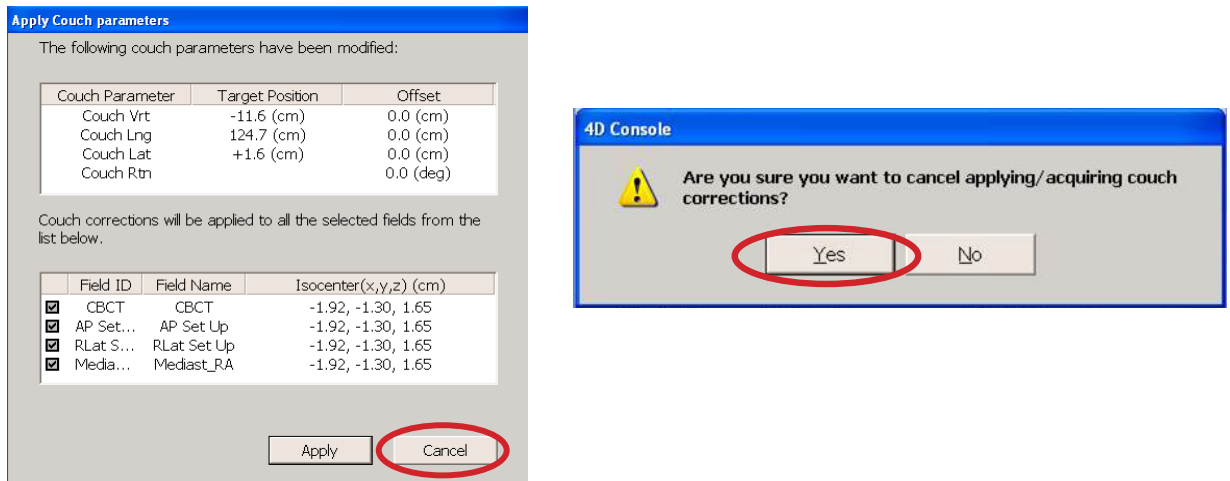

15. In **Varian 4DTC System**, **Mode Up** treatment field.

NOTE

Protura will lock during treatment with no option to unlock. Unlock option will be available at completion of each treatment field.

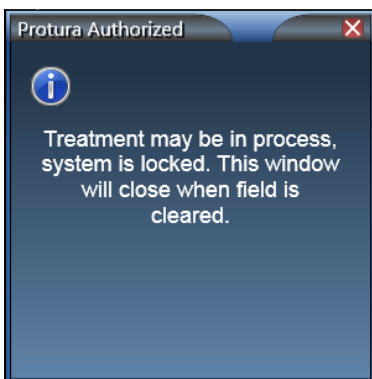

16. Follow treatment delivery protocol.

17. Repeat **STEPS 15-16** for all treatment fields at isocenter location.

18. Upon completion of treatment at current isocenter location, enter treatment room.

19. For treatment delivery at multiple isocenter locations on current patient:

1. Select **UNLOCK** in Protura software.



2. Move Protura to Zero Position.

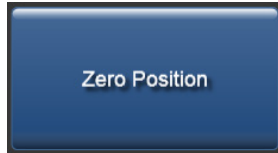

3. Select Unlock Pedestal Values.

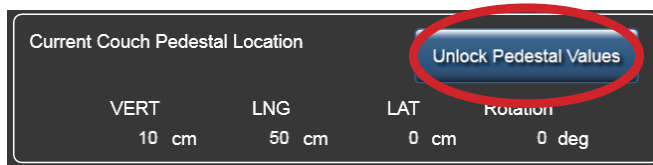

4. Repeat workflow beginning with step 5.

20. Close patient in **Varian 4DTC System** and/or **MOSAIQ**.

21. Select **UNLOCK** in Protura software.

22. When treatment is complete select **Load / Unload** button. Protura will move to **Load / Unload** position and automatically close patient record.

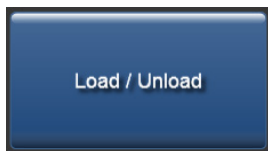

22. Patient may exit treatment room.

23. Generate **Patient Move Report** in Protura software at completion of treatment. Save report in patient file as defined in site protocol. Reports can be automatically generated upon closing of patient record and stored in defined directory location. Refer to *Section 7.2 Patient Move Report* and *Section 8.1 System Settings*.

6.3 Protura Workflow - Varian Integration with Pedestal Shifts

This section details workflow with Varian integration when Protura software applies shifts to Protura hardware and Varian pedestal. **Division of Movement** configuration must be set to **Translation Pedestal / Rotations Protura** OR **Translation and Yaw Pedestal / Pitch and Roll Protura**. Refer to Section 8.5 Varian Interface Settings.

WARNING



- Execution of QA tests is required following any updates to Varian 4DTC, OBI, ARIA, or MOSAIQ systems. Verify shift values calculated by Protura match the shifts generated in the OBI System.
- When making Protura shifts with Varian interface enabled, do not Apply Shifts to pedestal with the OBI System or other non-Protura systems. Protura will not update with new pedestal location, thus rotations will not occur at room isocenter and double shifts are possible.
- Ensure patient record in Varian 4DTC System matches patient record in Protura.
- Treatment authorization to Varian 4DTC System will remain active until Clear Mode Up is selected.

1. With Protura in **Load / Unload** position, **open** patient in **Varian 4DTC System** or **MOSAIQ**.
 - If selected patient exists in Protura database, patient record will automatically launch in Protura.
 - If selected patient does not exist in Protura database, **New Patient** message will be displayed. Click **Yes** to indicate patient will be treated using Protura. Patient record will be added to Protura and will automatically launch.

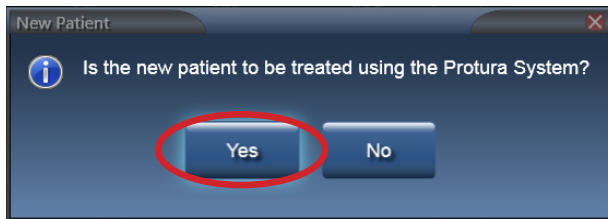

NOTE

If patient is not treated with Protura, refer to Section 6.4 Protura Workflow - Varian Integration without Protura.

2. In **Varian 4DTC System**, **Mode Up** the setup field.
3. Escort patient into treatment room and immobilize patient on couchtop as defined in treatment plan.
4. Move Protura to **Zero Position**.

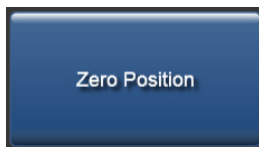

5. Align patient to external markers.
6. Exit treatment room.
7. Calculate shifts with **OBI System** to align target.

6 Protura Workflows

8. In OBI System, click **Save Match** and shift values are saved.

Couch Position (VAR IEC Scale, All units in cm and degrees) and Shift

Raw Shift Values				Machine Values					
	SHIFT		SHIFT	TARGET	ACTUAL	SHIFT			
Couch Vrt	-0.5	Couch Pitch	-1.0	12.0	12.5	-0.5	<input checked="" type="checkbox"/> Include	Reset Shift	
Couch Lng	+0.4	Couch Roll	+0.5	140.4	140.0	+0.4	<input checked="" type="checkbox"/> Include	Save Match	
Couch Lat	+0.3	Couch Rtn	-0.9	0.3	0.0	+0.3	<input checked="" type="checkbox"/> Include	Apply Shift	
		Couch Proj Rtn		359.1	0.0	-0.9	<input checked="" type="checkbox"/> Include		

NOTE

Protura software calculates shift values, gets pedestal location from the Varian 4DTC System (with a pedestal 0,0,0 move request), and locks the pedestal in Protura software.

9. Protura displays shift values and **Move** button becomes available.

WARNING



- Prior to selecting the Move button, verify pedestal and shift values in Protura match the IGRT system values.

10. Click **Move** button to move Protura and send shift data to Varian 4DTC System. The Current Couch Pedestal Location in the Protura software will update with the Varian pedestal Target Position.

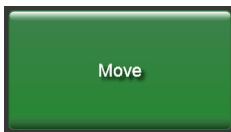

WARNING



- Verify pedestal position matches Protura move request.

Apply Couch parameters

The following couch parameters have been modified:

Couch Parameter	Target Position	Offset
Couch Vrt	999.6 (cm)	0.4 (cm)
Couch Lng	139.7 (cm)	0.3 (cm)
Couch Lat	0.1 (cm)	0.1 (cm)
Couch Rtn		0.0 (deg)

Couch corrections will be applied to all the selected fields from the list below.

Field ID	Field Name	Isocenter(x,y,z) (cm)
<input checked="" type="checkbox"/> KV RT...	KV RT LAT	0.00, 0.00, 0.00
<input checked="" type="checkbox"/> KV AP...	KV AP	0.00, 0.00, 0.00
<input checked="" type="checkbox"/> MV LT...	MV LT LAT	0.00, 0.00, 0.00
<input checked="" type="checkbox"/> MV A...	AP MV Setup	0.00, 0.00, 0.00

Apply Cancel

11. In **OBI System**, click **Cancel** and select **No** to apply shifts.

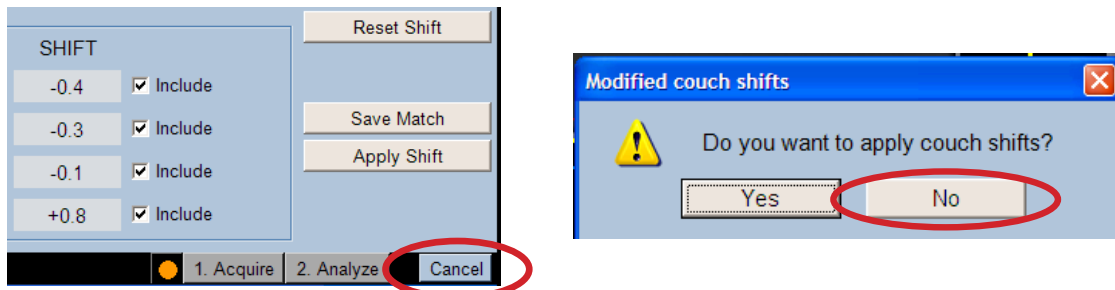

12. In **Varian 4DTC System**, click **Apply** to move pedestal with shifts sent from Protura.

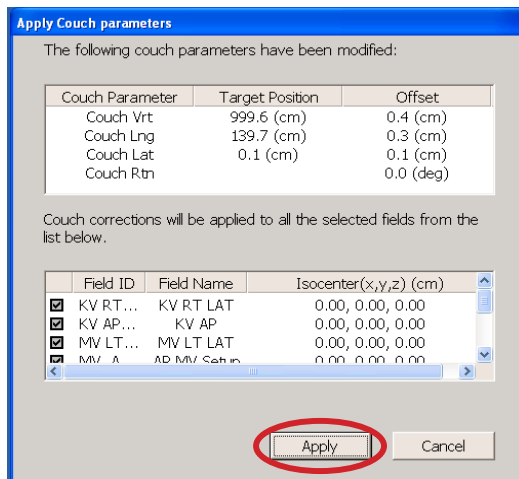

13. In **Varian Clinac**, press **Motion Enable** and **>>** keys to update pedestal position.

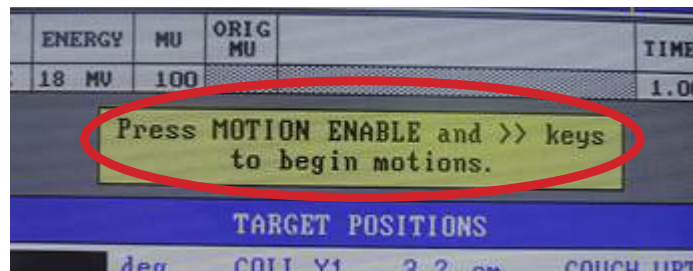

14. **Move Successful** message will be displayed in Protura system. Click **Yes** to confirm pedestal shifts have been made and to lock Protura for treatment.

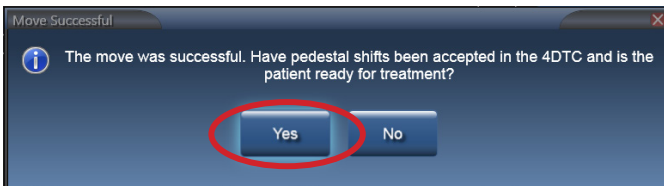

NOTE

A confirmation image is recommended to ensure patient and target are in the desired location before treatment is delivered. When making secondary shifts through the Protura software, the additional shifts will be performed as **All 6 Degrees Protura** with no shifts sent to the pedestal.

15. **Ready to Authorize** message will be displayed. To exit treatment mode, click **UNLOCK**.

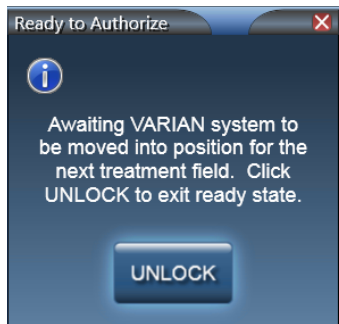

16. In **Varian 4DTC System**, click **Clear Mode Up**, then **Mode Up** treatment field.

NOTE

Protura will lock during treatment with no option to unlock. Unlock option will be available at completion of each treatment field.

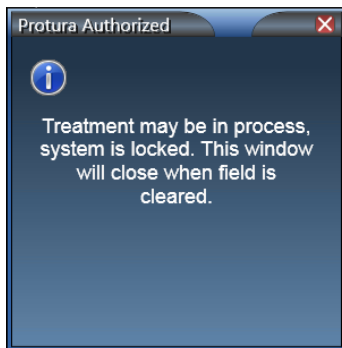

17. Follow treatment delivery protocol.

18. Repeat **STEPS 15-16** for all treatment fields at isocenter location.

19. Upon completion of treatment at current isocenter location, enter treatment room.

20. For treatment delivery at multiple isocenter locations on current patient:

1. Select **UNLOCK** in Protura software.



2. Move Protura to Zero Position.

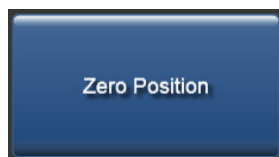

3. Select **Unlock Pedestal Values**.

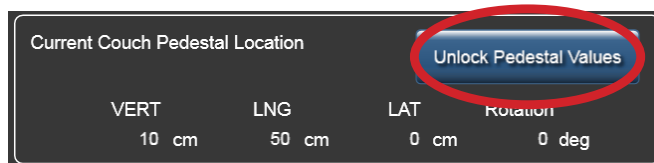

4. Repeat workflow beginning with step 5.

6 Protura Workflows

21. Close patient in **Varian 4DTC System** and/or **MOSAIQ**.
22. Select **UNLOCK** in Protura software.
23. When treatment is complete select **Load / Unload** button. Protura will move to **Load / Unload** position and automatically close patient record.

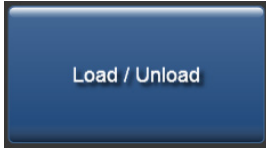

24. Patient may exit treatment room.
25. Generate **Patient Move Report** in Protura software at completion of treatment. Save report in patient file as defined in site protocol. Reports can be automatically generated upon closing of patient record and stored in defined directory location. *Refer to Section 7.2 Patient Move Report and Section 8.1 System Settings.*

6.4 Protura Workflow – Varian Integration without Protura

This section details workflow using Varian 4DTC System only.

WARNING



- Ensure patient record in Varian 4DTC System matches patient record in Protura.
- Treatment authorization to Varian 4DTC System will remain active until Clear Mode Up is selected.

1. With Protura in **Load / Unload** position, **open** patient in **Varian 4DTC System** or **MOSAIQ**.
 - If selected patient exists in Protura database, patient record will automatically launch in Protura. Patient record configuration must have “Patient Treatment uses Protura” unchecked. Refer to Section 5.1.3 Edit Patient Record.
 - If selected patient does not exist in Protura database, **New Patient** message will be displayed. Click **No** to indicate patient is not being treated using the Protura System. Patient record will be added to Protura and will automatically launch.

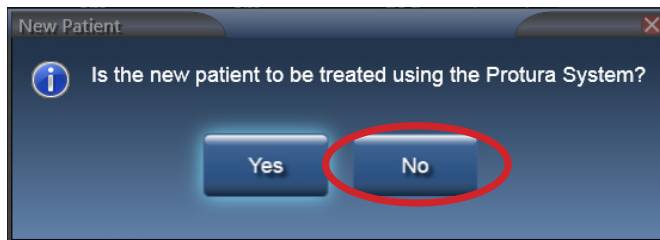

- Left linac light is blue when a non-Protura patient is loaded.

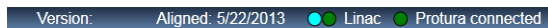

2. In **Varian 4DTC System, Mode Up** the set up field.
3. Escort patient into treatment room and immobilize patient on couchtop as defined in treatment plan.
4. Move Protura to **Zero Position**.



5. Align patient to external markers.
6. Exit treatment room.
7. Calculate shifts with IGRT system to align target.
8. Position patient as needed for treatment:
 - Apply shifts through pedestal.
 - If patient is rotated, use method other than Protura to correct rotations.
 - Re-enter room to reposition patient, re-image patient with updated location.
9. Repeat **STEPS 7-8** as needed for accurate patient positioning.
10. In **Varian 4DTC System, Mode Up** treatment field.

6 Protura Workflows

NOTE

Protura will be locked for treatment with no unlock option during treatment. Unlock option will be available at completion of each treatment field.

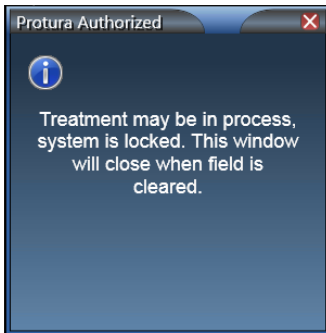

11. Follow treatment delivery protocol.
12. Repeat **STEPS 10-11** for all treatment fields at isocenter location.
13. Upon completion of treatment at current isocenter location, enter treatment room.
14. For treatment delivery at multiple isocenter locations on current patient, repeat workflow beginning with step 5.
15. **Close** patient in **Varian 4DTC System** and/or **MOSAIQ**.
16. Select **UNLOCK** in Protura software.
17. When treatment is complete select **Load / Unload** button. Protura will move to **Load / Unload** position and automatically close patient record.

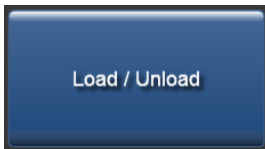

18. Patient may exit treatment room.

6.5 Protura Workflow - Elekta Integration

This section details workflow with Elekta, MOSAIQ and XVI integrations with 6DOF with Protura. In this workflow, Protura is able to monitor pedestal coordinates at all times. Define configurations in Elekta Interface tab (*refer to Section 8.6 Elekta Interface Settings*).

WARNING



- Ensure existing patient in Protura is closed prior to opening new patient in MOSAIQ.

1. With Protura in **Load / Unload** position, **open** patient in **MOSAIQ System** and patient record will automatically launch in Protura.
2. Escort patient into treatment room and immobilize patient on couchtop as defined in treatment plan.
3. Raise pedestal to align patient to external markers.
 - If configuration is set to **Auto Load / Zero**, Protura will automatically move to **Zero Position** when pedestal vertical and longitudinal coordinates meet the configured values. *Refer to Section 8.6 Elekta Interface Settings*.
 - If not configured for **Auto Load / Zero**, use touch screen in vault to move Protura to **Zero Position**.

NOTE

Current pedestal position is automatically updated and displayed in real time in Protura.

4. Select **Lock Pedestal Values** in Protura.

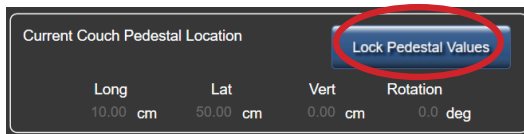

5. Exit treatment room.
6. Calculate shifts with **Elekta XVI System** to align target. Ensure selected IGRT matches XVI System.
7. **Save** shifts in **Elekta XVI System** and click **Import** to manually import shift values into Protura.



WARNING



- Prior to selecting the **Move** button, verify pedestal and shift values in Protura match the IGRT system values.

8. Click **Move** button to move Protura into treatment position.

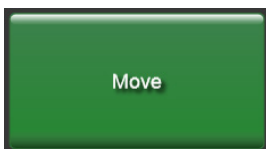

9. **Move Successful** message will be displayed in Protura. Click **Yes** to lock Protura for treatment.

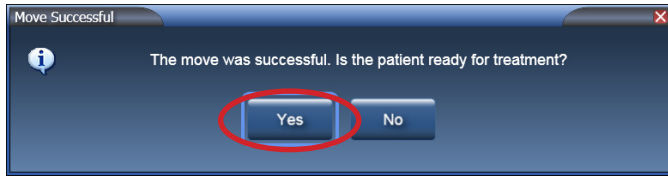

NOTE

A confirmation image is recommended to ensure patient and target are in the desired location before treatment is delivered. Protura configuration can be set to allow unlocking in treatment mode or the unlock feature can be disabled. *Refer to Section 8.6 Elekta Interface Settings.*

10. Follow treatment delivery protocol.
11. Upon completion of treatment at current isocenter location, enter treatment room.
12. For treatment delivery at multiple isocenter locations on current patient:

1. Select **UNLOCK** in Protura software.



2. Move Protura to Zero Position.

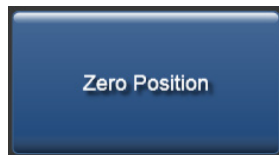

3. Select Unlock Pedestal Values.

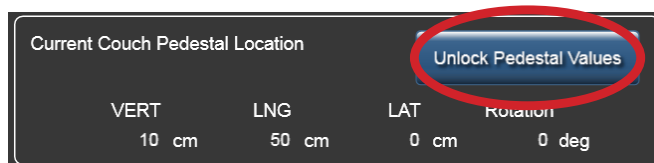

4. Align patient to external markers.
5. Repeat workflow beginning with step 4.

13. **Close** patient record in **MOSAIQ**.

14. Select **UNLOCK** in Protura software.

15. Lower pedestal.

- If configuration is set to **Auto Load / Zero**, Protura will automatically move to **Load / Unload** position when pedestal vertical and longitudinal coordinates meet the configured values and patient record will automatically close.

16. Patient may exit treatment room.

17. Generate **Patient Move Report** in Protura software at completion of treatment. Save report in patient file as defined in site protocol. Reports can be automatically generated upon closing of patient record and stored in defined directory location. *Refer to Section 7.2 Patient Move Report and Section 8.1 System Settings.*

6.6 Protura Workflow - Remote Control

This section details workflow for a Remote Control System (i.e. AlignRT) operating the Protura hardware.

WARNING



- When the pedestal is moved from the locked position prior to a secondary Protura rotation, a confirmation image is required after the secondary Protura rotation to verify any residual error is within treatment tolerance.

- With Protura in **Load / Unload** position, **open** patient in **Remote Control System**. Patient record will automatically launch in Protura.
- Escort patient into treatment room and immobilize patient on couchtop as defined in treatment plan.
- Raise pedestal and move Protura to **Zero Position** using buttons on Protura couch or via Remote Control System.

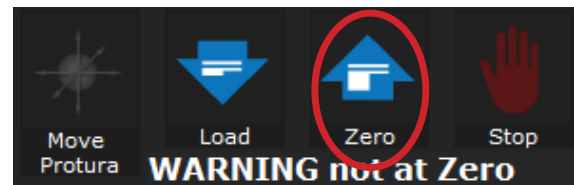

- Align patient to external markers.
- Exit treatment room.
- Calculate shifts with **Remote Control System** to align target.
- Click **Move Protura** in **Remote Control System**.

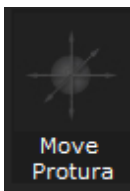

- Change values to reflect current position of pedestal to match Protura and click **Apply** in **Remote Control System** to send current pedestal positions to Protura.



6 Protura Workflows

9. Click **Apply** a second time to apply shifts in Protura.

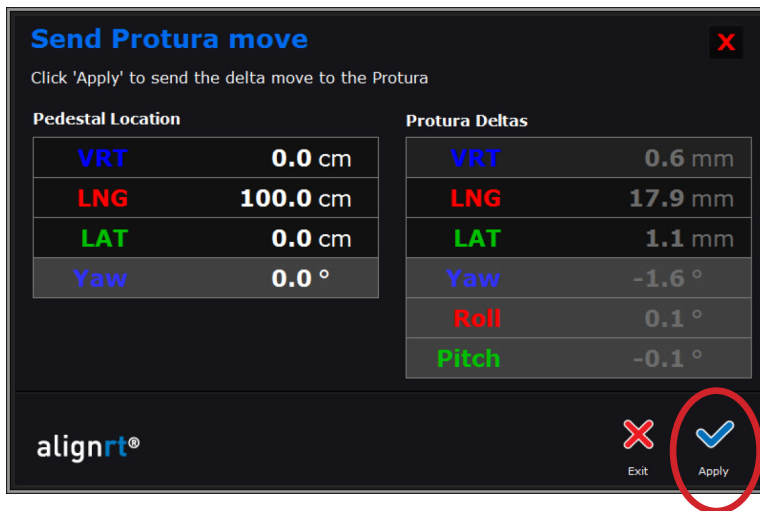

10. Click **Verify** to confirm shifts were applied correctly.

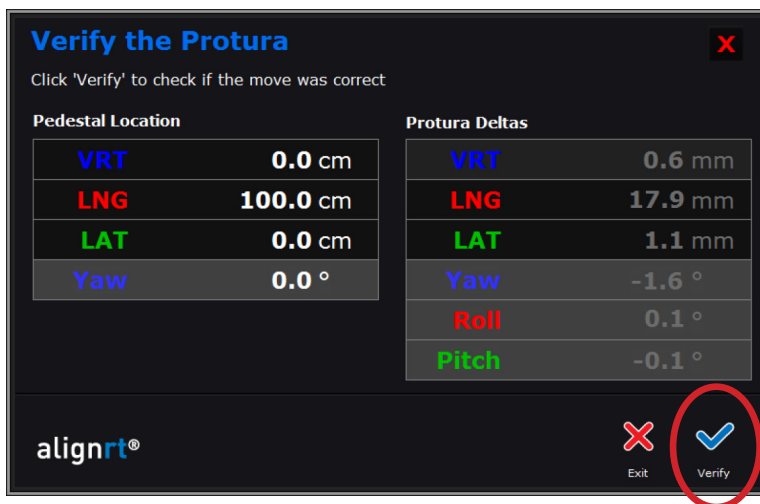

11. Follow treatment delivery protocol.
12. Upon completion of treatment at current isocenter location, enter treatment room.
13. For treatment delivery at multiple isocenter locations on current patient:
 1. Select **UNLOCK** in Protura software.



2. Move Protura to Zero Position.

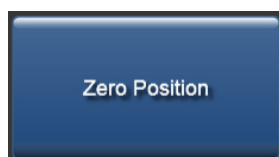

3. Select Unlock Pedestal Values.

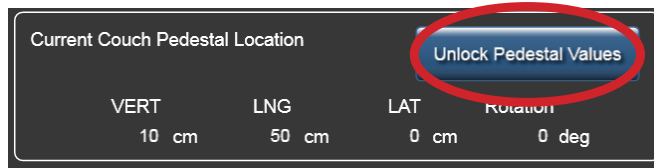

4. Repeat workflow beginning with step 4.

14. Close patient in Remote Control System.

15. Select **UNLOCK** in Protura software.

16. When treatment is complete, move Protura into **Load / Unload** position using buttons on Protura couch or via Remote Control System. Patient record will automatically close.



17. Patient may exit treatment room.

18. Generate **Patient Move Report** in Protura software at completion of treatment. Save report in patient file as defined in site protocol. Reports can be automatically generated upon closing of patient record and stored in defined directory location. Refer to *Section 7.2 Patient Move Report and Section 8.1 System Settings*.

6.7 Protura Workflow - Remote Control with Linac Integration

This section details workflow for a Remote Control System (*i.e. Align RT*) operating the Protura hardware with Linac integration.

WARNING



- Execution of QA tests is required following any updates to Varian 4DTC, OBI, ARIA, or MOSAIQ systems. Verify shift values calculated by Protura match the shifts generated in the OBI System.
- When making Protura shifts with Varian interface enabled, do not Apply Shifts to pedestal with the OBI System or other non-Protura systems. Protura will not update with new pedestal location, thus rotations will not occur at room isocenter and double shifts are possible.
- Ensure patient record in Varian 4DTC System matches patient record in Protura.
- Treatment authorization to Varian 4DTC System will remain active until Clear Mode Up is selected.
- Ensure existing patient in Protura is closed prior to opening new patient in MOSAIQ.

1. With Protura in **Load / Unload** position, open patient in **Varian 4DTC System** or **MOSAIQ**.

FOR VARIAN SYSTEM CONFIGURATIONS:

- If selected patient exists in Protura database, patient record will automatically launch in Protura.
- If selected patient does not exist in Protura database, **New Patient** message will be displayed. Click **Yes** to indicate patient will be treated using Protura. Patient record will be added to Protura and will automatically launch.

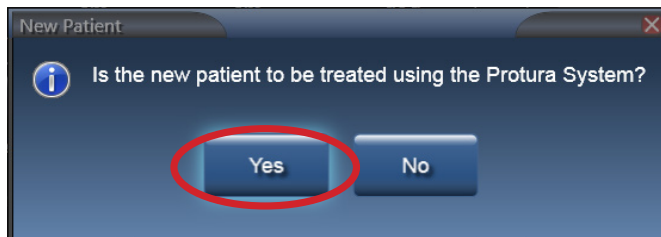

NOTE:

To set indicator if patient will be treated with Protura, refer to Section 5.1.3 Edit Patient Record.

2. Escort patient into treatment room and immobilize patient on couchtop as defined in treatment plan.
3. In linac **IGRT System, Mode Up** the setup field, as necessary.
4. Raise pedestal and move Protura to **Zero Position** by one of the following:

**CLICK ZERO POSITION
IN PROTURA SOFTWARE**

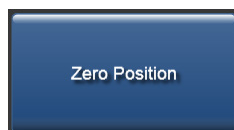

CLICK ZERO IN REMOTE CONTROL SYSTEM

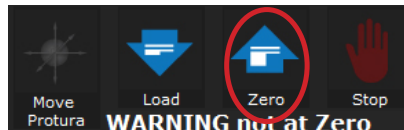

5. Align patient to external markers.
6. Exit treatment room.
7. Calculate shifts with linac **IGRT System** to align target.

NOTE

For Elekta system configurations, **Lock Pedestal Values** in Protura software.

6 Protura Workflows

8. Save shifts in linac **IGRT System**; these values will automatically populate in Protura.
9. Protura displays shift values and **Move** button becomes available.

WARNING



- Prior to selecting the **Move** button, verify pedestal and shift values in Protura match the IGRT system values.

10. Click **Move** button to move Protura into treatment position.

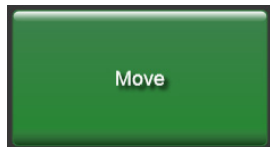

11. **Move Successful** message will be displayed in Protura system. Click **Yes** to lock Protura for treatment.

VARIAN SYSTEM MESSAGE

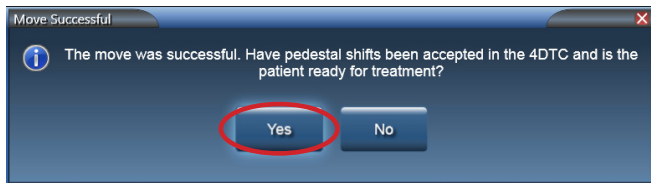

NON-VARIAN SYSTEM MESSAGE

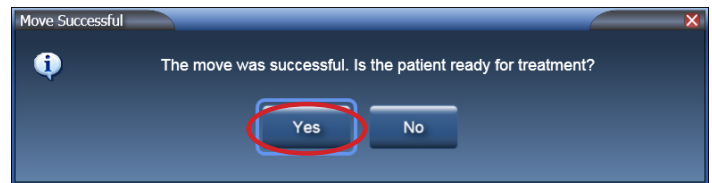

12. **Ready for Treatment** message will be displayed. System is now locked and ready for treatment.

VARIAN SYSTEM MESSAGE

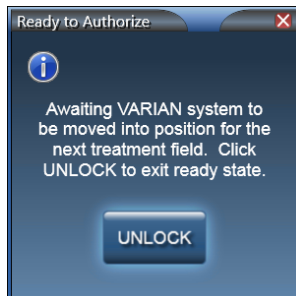

NON-VARIAN SYSTEM MESSAGE

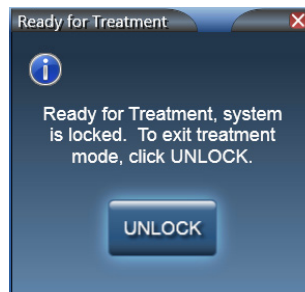

13. In the **Remote Control System**, **Capture** a new **Reference** image.

FOR REMOTE CONTROL SYSTEM SHIFTS: (If no additional shifts are needed, continue with **Step 14**).

- Click **Unlock** to indicate patient is not ready for treatment and additional shifts are needed.

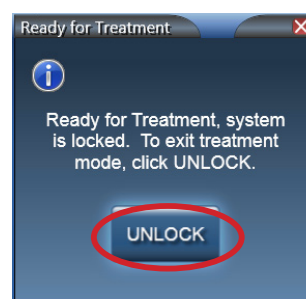
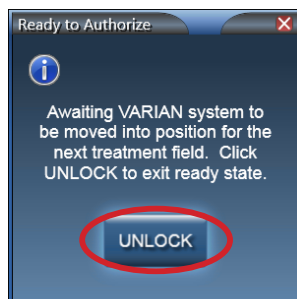

FOR REMOTE CONTROL SYSTEM SHIFTS (Cont.):

- Apply shifts with the Remote Control System.

NOTE:

Protura ignores the pedestal position being sent from the Remote Control System. Shift values are imported from the IGRT system and appear as “Current Values” in Protura.

- Click **Move Protura** in **Remote Control System**.

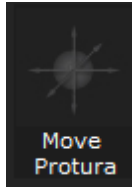

- Change values to reflect current position of pedestal to match Protura and click **Apply** in **Remote Control System**. With linac interface enabled, Protura will import and lock the pedestal location when shifts are sent from the Remote Control System.



- Click **Apply** a second time to apply shifts in Protura.

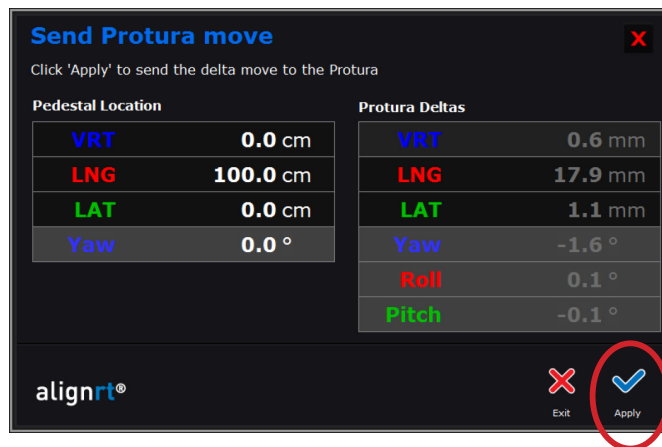

- Click **Verify** to confirm shifts were applied correctly.

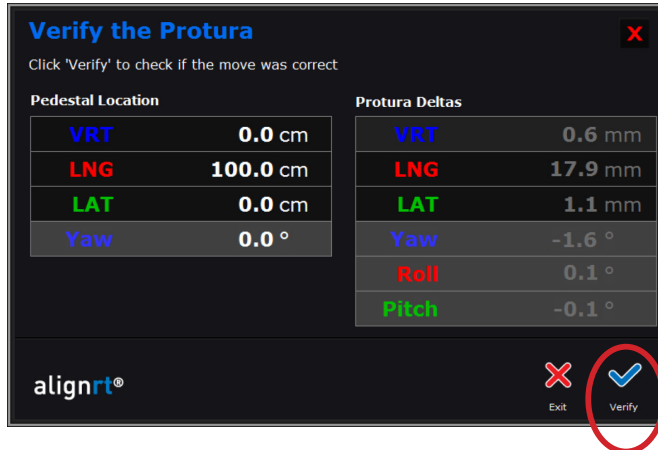

- If additional shifts are required from Remote Control system, click **UNLOCK** and repeat **Remote Control System Steps**. When ready for treatment, continue with **Step 14**.

NOTE:

If pedestal is not already locked, Varian system configurations require Mode Up the setup field prior to AlignRT move to allow Protura to capture pedestal location.

A confirmation image is recommended to ensure patient and target are in the desired location before treatment is delivered.

When making secondary shifts through the Protura software, the additional shifts will be performed as **All 6 Degrees Protura** with no shifts sent to the pedestal.

FOR VARIAN SYSTEM CONFIGURATION:

- In **OBI System**, click **Cancel** and select **No** to apply shifts.
- In **Varian 4DTC System**, click **Cancel** to pedestal move request 0,0,0, which is sent from Protura to access pedestal location.
- **Mode Up** treatment field.

NOTE:

Protura will lock during treatment with no option to unlock. Unlock option will be available at completion of each treatment field.

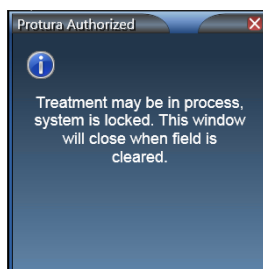

6 Protura Workflows

14. Follow treatment delivery protocol.
15. Upon completion of treatment at current isocenter location, enter treatment room.
16. Select **UNLOCK** in Protura software.
17. For treatment delivery at multiple isocenter locations on current patient:

1. Move Protura to Zero Position.

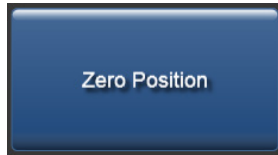

2. Select Unlock Pedestal Values.

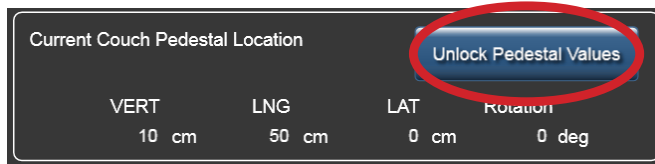

3. Repeat workflow beginning with step 5.

18. When treatment is complete, select **Load / Unload** button. Protura will move to **Load / Unload** position.

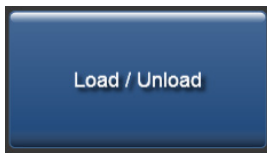

19. Close patient in **4DTC** or **MOSAIQ, Remote Control System**, and **Protura** software.
20. Patient may exit treatment room.
21. Generate **Patient Move Report** in Protura software at completion of treatment. Save report in patient file as defined in site protocol. Reports can be automatically generated upon closing of patient record and stored in defined directory location. Refer to *Section 7.2 Patient Move Report* and *Section 8.1 System Settings*.

6.8 Protura Workflow - File Import

This section details workflow using an Import file in Protura. Imported file will be in ASCII format.

1. Escort patient into treatment room and with Protura in **Load / Unload** position, immobilize patient on couchtop as defined in treatment plan.

2. Move Protura to **Zero Position**.

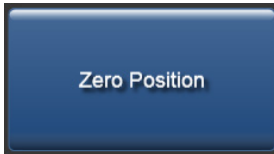

3. Align patient to external markers.

4. Exit treatment room.

5. Calculate shifts using an IGRT system to align target.

6. **Export** IGRT information to an ASCII data file.

7. At Protura workstation, select **Import** button for direct access to Import data files. There are several options to initiate the Import button.

- From the **File** menu, click **Import...**
- Click **Import** in the **Couch Position Panel**.
- Select **[Ctrl]+I** on the keyboard.

If a patient is not loaded, **Import** will input patient data. If a patient is already loaded, **Import** will input IGRT data. **Import** will verify if imported files match the imported patient. If they do not match, the user is given the option to import or cancel.

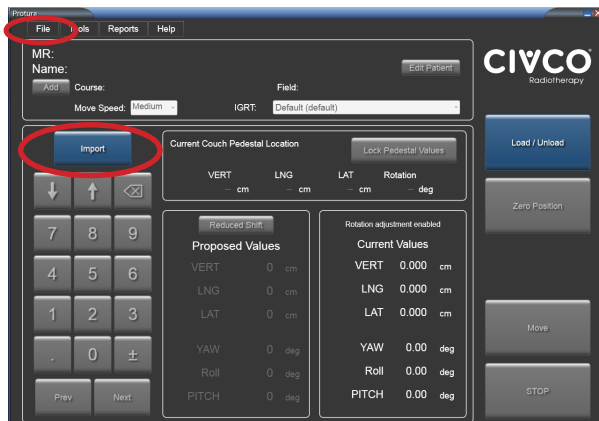

6 Protura Workflows

8. Select file for import. File is imported and values are populated into **MR Number, First Name, Last Name, Course, Field, Couch Pedestal X Y Z Coordinate** and **six IGRT shift values**.

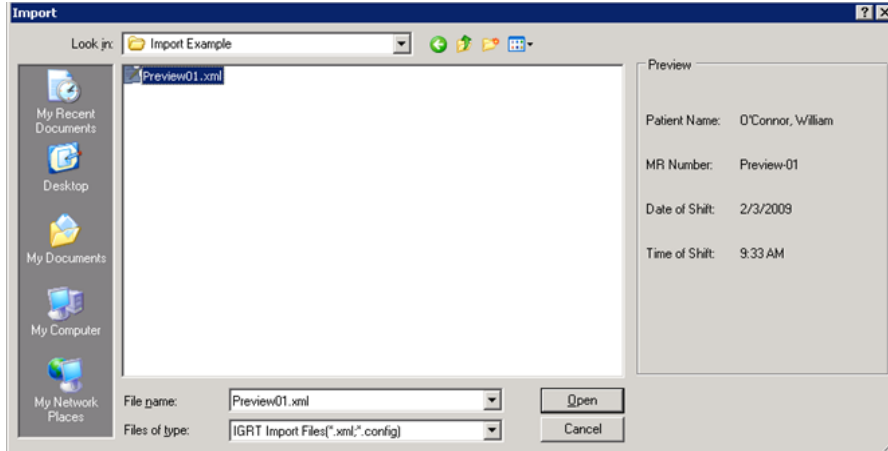

NOTE

MR Number, First Name and Last Name are required fields to save the patient record. If this information is missing from import file, it will need to be entered (*refer to Section 5.1.1 Create Patient Record*).

Different oncology information systems and linac vendors use different file formats for exporting data. Please check with CIVCO Customer Service to make sure the file format you are using is supported by Protura.

9. Click in each field of **Current Couch Pedestal Location** screen to confirm displayed values. Select **Lock Pedestal Values**.

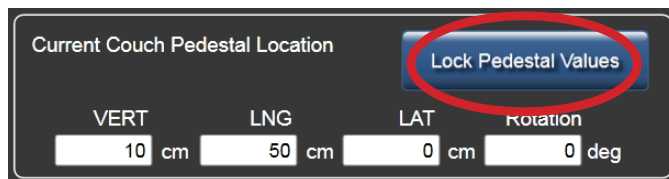

WARNING



- Prior to selecting the Move button, verify pedestal and shift values in Protura match the IGRT system values.

10. Click **Move** button to move Protura into treatment position.

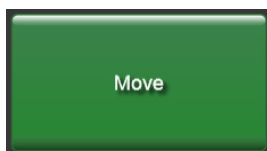

11. **Move Successful** message will be displayed. Click **Yes** to lock Protura for treatment.

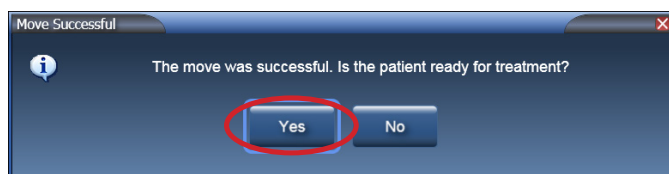

6 Protura Workflows

NOTE

A confirmation image is recommended to ensure patient and target are in the desired location before treatment is delivered.

12. **Ready for Treatment** message will be displayed.

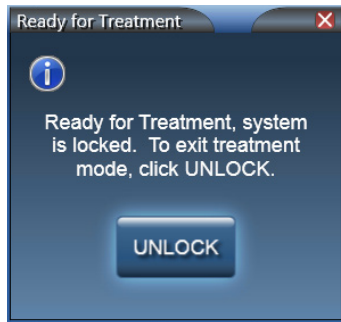

13. Follow treatment delivery protocol.

14. Upon completion of treatment at current isocenter location, enter treatment room.

15. Select **UNLOCK** in Protura software.

16. For treatment delivery at multiple isocenter locations on current patient:

1. Move Protura to Zero Position.

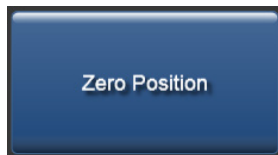

2. Select Unlock Pedestal Values.

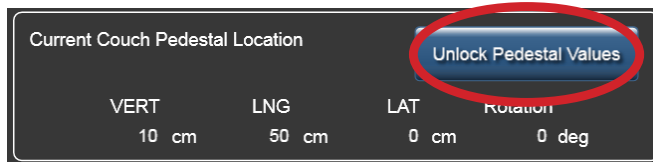

3. Repeat workflow beginning with step 3.

17. When treatment is complete, select **Load / Unload** button. Protura will move to **Load / Unload** position and automatically close patient record.

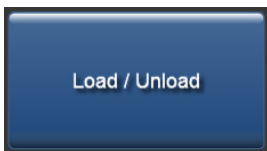

18. Patient may exit treatment room.

19. Generate **Patient Move Report** in Protura software at completion of treatment. Save report in patient file as defined in site protocol. Reports can be automatically generated upon closing of patient record and stored in defined directory location. Refer to *Section 7.2 Patient Move Report and Section 8.1 System Settings*.

7 Reports

There are two types of Patient Reports:

- Daily Move Report
- Patient Move Report

Reports can be filtered on both patient and date criteria. These reports can be viewed, printed to paper or saved as PDF for import into other information systems.

1. From the **Reports** menu, click **Generate Patient Reports...**

Generate Patient Reports

Report Type: Patient Move Report Daily Move Report

Date Range: All Dates From To

Patient(s):

Last Name: First Name: MR Number:

Last Name ^	First Name	MR Number
Doe	John	3195300265

2. Select **Report Type** option.
3. Select appropriate **Date Range** option.
4. Select appropriate **Patient(s)** option.

NOTE

Date Range defaults to **Today**.

Multiple contiguous rows can be selected by using [Shift]+click. Multiple non-contiguous rows can be selected by using [Ctrl]+click.

5. Click **Create Report**. The report will open in a new window titled *Preview Report*.

7.1 Daily Move Report

The **Daily Move Report** is generated when a single date is selected from **Date Range** option.

Daily Move Report displays:

- Generated Date
- Protura Version
- IGRT Coordinate System
- IGRT Configuration Date
- Moves performed on selected date (grouped by MR number then time)
- Protura Location as defined in System Settings
- Move Date

Patients are separated by shaded header containing IGRT system information.

Protura Daily Move Report Generated: Wednesday, July 08, 2015 7:53:08
Version:

Protura Location: Test Location
Date: Wednesday, July 08, 2015

IGRT Coordinate System: mm IGRT Configuration Date: Wednesday, July 08, 2015

Time	Course/Field	Last Name/MR #	Translation Start / Stop (mm)			Rotation Start / Stop (deg)			Trmt
			VERT	LNG	LAT	YAW	ROLL	PITCH	
7:50	C2 / F1	Doe / 123-456-789	0 / 7.1	0 / -4.2	0 / -2.6	0 / -1.11	0 / -2.56	0 / 2.05	Yes
7:49	C1 /	Doe / 123-456-789	0 / 2	0 / 2.8	0 / 1.9	0 / 2.29	0 / 0.55	0 / 1.22	Yes
7:48	C1 /	Doe / 123-456-789	0 / 0.6	0 / 1.8	0 / 5.3	0 / 2.19	0 / 0.76	0 / 1.03	No
7:47	C1 /	Doe / 123-456-789	15 / 15	2.3 / 2.3	1.8 / 1.8	0.58 / 0.48	0.79 / 1.49	1.01 / 0.81	No
7:46	C1 /	Doe / 123-456-789	15 / 15	2.3 / 2.3	1.8 / 1.8	0.48 / 0.58	0.79 / 0.79	1.21 / 1.01	No
7:45	C1 /	Doe / 123-456-789	5 / 15	0 / 2.3	0 / 1.8	0 / 0.48	0 / 0.79	0 / 1.21	No
7:43	XZ-test /	Doe / MR-test-1	10 / 5	0 / 0	0 / 0	0 / 0	0 / 0	0 / 0	Yes
7:43	XZ-test /	Doe / MR-test-1	0 / 10	0 / 0	0 / 0	0 / 0	0 / 0	0 / 0	Yes

Page 1 of 1

7.2 Patient Move Report

The **Patient Move Report** is generated when **All** or **From** and **To** choices (*with different dates*) is selected from **Date Range** option.

Patient Move Report displays:

- Generated Date
- Protura Version
- MR Number
- First Name
- Last Name
- Period

For each treatment date:

- IGRT Coordinate System
- IGRT Configuration Date
- Protura Location as defined in system settings
- Move Date
- Moves performed (grouped by patient then location)

The **Patient Move Report** lists patient moves performed during the selected date range. Patients are separated by shaded header containing patient information.

The **Patient Move Report** can be set to automatically save a new report to a defined directory each time a patient record is closed and if moves have occurred. **Auto Save Reports** must be enabled and report will be saved in the defined directory as yyyy-mm-dd_MR#_DailyReport.pdf. Refer to Section 8.1 System Settings.

Protura Patient Move Report
Generated: Wednesday, July 08, 2015 7:54:31
Version:

MR Number: 123-456-789
First Name: George
Last Name: Doe
Period: Wednesday, July 08, 2015

IGRT Coordinate System: mm
Move Date: Wednesday, July 08, 2015
IGRT Configuration Date: Wednesday, July 08, 2015
Protura Location: Test Location

Time	Course/Field	Pedestal (cm)			Pedestal Rot (deg)	Speed	Translation Start / Stop (mm)			Rotation Start / Stop (deg)			Trmt
		VERT	LNG	LAT			VERT	LNG	LAT	YAW	ROLL	PITCH	
7:50	C2 / F1	0	0	0	0	Low	0 / 7.1	0 / -4.2	0 / -2.6	0 / -1.11	0 / -2.56	0 / 2.05	Yes
7:49	C1 /	0	0	0	0	Low	0 / 2	0 / 2.8	0 / 1.9	0 / 2.29	0 / 0.55	0 / 1.22	Yes
7:48	C1 /	0	0	0	0	Low	0 / 0.6	0 / 1.8	0 / 5.3	0 / 2.19	0 / 0.76	0 / 1.03	No
7:47	C1 /	0	0	0	0	Low	15 / 15	2.3 / 2.3	1.8 / 1.8	0.58 / 0.48	0.79 / 1.49	1.01 / 0.81	No
7:46	C1 /	0	0	0	0	Low	15 / 15	2.3 / 2.3	1.8 / 1.8	0.48 / 0.58	0.79 / 0.79	1.21 / 1.01	No
7:45	C1 /	0	0	0	0	Low	5 / 15	0 / 2.3	0 / 1.8	0 / 0.48	0 / 0.79	0 / 1.21	No

Page 1 of 1

7.3 Preview Report Overview

Preview Report Window is divided into three parts: **Options**, **Report Body** and **Find**.

The screenshot shows a window titled "Preview Report" with a toolbar at the top containing icons for print, save, and other functions. Callout I points to this toolbar. The main report area contains the Protura logo, report title "Daily Move Report", and generation date "Wednesday, July 08, 2015 7:53:08". Below this is a table with columns for Time, Course/Field, Last Name/MR #, Translation Start/Stop (mm) (VERT, LNG, LAT), Rotation Start/Stop (deg) (YAW, ROLL, PITCH), and Trmt. Callout II points to this table. At the bottom of the window is a search bar with the placeholder text "Type text to find...". Callout III points to this search bar.

Time	Course/Field	Last Name/MR #	Translation Start / Stop (mm)			Rotation Start / Stop (deg)			Trmt
			VERT	LNG	LAT	YAW	ROLL	PITCH	
7:50	C2 / F1	Doe / 123-456-789	0 / 7.1	0 / -4.2	0 / -2.6	0 / -1.11	0 / -2.56	0 / 2.05	Yes
7:49	C1 /	Doe / 123-456-789	0 / 2	0 / 2.8	0 / 1.9	0 / 2.29	0 / 0.55	0 / 1.22	Yes
7:48	C1 /	Doe / 123-456-789	0 / 0.6	0 / 1.8	0 / 5.3	0 / 2.19	0 / 0.76	0 / 1.03	No
7:47	C1 /	Doe / 123-456-789	15 / 15	2.3 / 2.3	1.8 / 1.8	0.58 / 0.48	0.79 / 1.49	1.01 / 0.81	No
7:46	C1 /	Doe / 123-456-789	15 / 15	2.3 / 2.3	1.8 / 1.8	0.48 / 0.58	0.79 / 0.79	1.21 / 1.01	No
7:45	C1 /	Doe / 123-456-789	5 / 15	0 / 2.3	0 / 1.8	0 / 0.48	0 / 0.79	0 / 1.21	No
7:43	XZ-test /	Doe / MR-test-1	10 / 5	0 / 0	0 / 0	0 / 0	0 / 0	0 / 0	Yes
7:43	XZ-test /	Doe / MR-test-1	0 / 10	0 / 0	0 / 0	0 / 0	0 / 0	0 / 0	Yes

I. Options

Options are located in the upper-left corner of the window.



Saving a PDF



1. Click **PDF** icon. **Save As** window is displayed. Update filename and choose appropriate save destination. Click **Save**.

Print Report



2. Click **Printer** icon. **Print** window is displayed. Choose appropriate print options. Click **Print**.

Copy Selected Text



3. Highlight text to be copied (*[Ctrl]+A selects all text*). Click **Copy Selected Text** icon. Paste text into desired application.

Whole Page / Two Page Across



4. Change view options by selecting either **Whole Page** or **Two Pages Across** icons.

II. Report Body

This area contains details in the Daily or Patient Move Reports.

Time: Recorded time of move.

Course/Field: Selected Course and Field for move.

Last Name/MR #: Patient's last name and MR # (*Daily Move Report only*).

Pedestal (cm or mm): Displays couch pedestal information (*Patient Move Report only*).

Pedestal Rot (deg): Displays degrees the pedestal was rotated (*Patient Move Report only*).

Speed: Identifies selected move speed (*Patient Move Report only*).

Translation Start / Stop (cm or mm): Recorded Start and Stop locations for translation X, Y and Z axes, based upon IGRT Coordinate System used.

Rotation Start / Stop (deg): Recorded Start and Stop locations for rotation U, V and W axes, based upon IGRT Coordinate System used.

Trmt: Identifies if move resulted in treatment.

Daily Move Report

Time	Course/Field	Last Name/MR #	Translation Start / Stop (mm)			Rotation Start / Stop (deg)			Trmt
			VERT	LNG	LAT	YAW	ROLL	PITCH	
7:50	C2 / F1	Doe / 123-456-789	0 / 7.1	0 / -4.2	0 / -2.6	0 / -1.11	0 / -2.56	0 / 2.05	Yes
7:49	C1 /	Doe / 123-456-789	0 / 2	0 / 2.8	0 / 1.9	0 / 2.29	0 / 0.55	0 / 1.22	Yes
7:48	C1 /	Doe / 123-456-789	0 / 0.6	0 / 1.8	0 / 5.3	0 / 2.19	0 / 0.76	0 / 1.03	No
7:47	C1 /	Doe / 123-456-789	15 / 15	2.3 / 2.3	1.8 / 1.8	0.58 / 0.48	0.79 / 1.49	1.01 / 0.81	No

Patient Move Report

Time	Course/Field	Pedestal (cm)			Pedestal Rot (deg)	Speed	Translation Start / Stop (mm)			Rotation Start / Stop (deg)			Trmt
		VERT	LNG	LAT			VERT	LNG	LAT	YAW	ROLL	PITCH	
7:50	C2 / F1	0	0	0	0	Low	0 / 7.1	0 / -4.2	0 / -2.6	0 / -1.11	0 / -2.56	0 / 2.05	Yes
7:49	C1 /	0	0	0	0	Low	0 / 2	0 / 2.8	0 / 1.9	0 / 2.29	0 / 0.55	0 / 1.22	Yes
7:48	C1 /	0	0	0	0	Low	0 / 0.6	0 / 1.8	0 / 5.3	0 / 2.19	0 / 0.76	0 / 1.03	No
7:47	C1 /	0	0	0	0	Low	15 / 15	2.3 / 2.3	1.8 / 1.8	0.58 / 0.48	0.79 / 1.49	1.01 / 0.81	No

III. Find

Find is located in the lower-left corner of the window. Find allows user to search report by key words. Down arrow allows for different find options.



8 Configurations and Settings

The Protura application must be configured according to the specific setup of the treatment facility.

WARNING



- Prior to clinical use, alignment is required to set Protura pivot point (refer to Section 8.4 Isocenter Alignment).
- Execution of QA tests is required during Protura installation and IGRT system configuration to assure proper results. Failure to do so can result in patient mistreatment. Always verify shifts through re-imaging and verification and IGRT.
- Protura units are in millimeters and/or centimeters (as defined in Section 8.3 IGRT Coordinate System Configuration and Section 8.2 Couch Pedestal Configuration). Ensure correct values when entered into the system.

From the **Tools** menu, click **Configure....**

The **Configurations and Settings** window is displayed. This panel contains six tabs:

- **System Settings**
- **Couch Pedestal Configuration**
- **IGRT Coordinate System Configuration**
- **Isocenter Alignment**
- **Elekta Interface Settings**
- **Varian Interface Settings**

Configuration tabs are locked when window is opened. Click the **LOCK** to unlock settings.



To leave **Configuration** window without making changes, click **Cancel**.

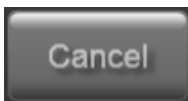

Enter Password window is displayed. There are two methods to enter password:

- Enter password (default password is **CeePro**, refer to Section 8.1 System Settings). Click **OK**.
- Click the keyboard icon. Enter password using a mouse or touch screen (default password is **CeePro**, refer to Section 8.1 System Settings). Click **OK**.

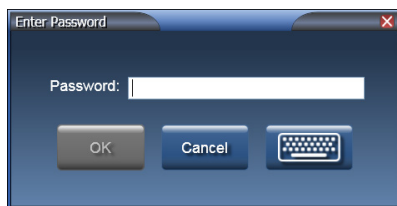

NOTE

Settings cannot be defined or updated if a patient file is open.

To leave **Enter Password** window without making changes, click **Cancel**.

8.1 System Settings

System Settings tab contains:

Time Display Format: Sets time display to 12 hour format or 24 hour format.

Patient Data Location: This directory is where all the patient data will be stored. If patient data is being shared among multiple treatment rooms, a shared location accessible by all Protura applications is required. The files in this location are used for generating reports, keeping a daily record of pedestal locations and shifts used for treatment. Click **Browse** to locate directory.

NOTE Ensure all users have read/write access to directory where data is stored.

Import Files Location: This directory is where the Protura application **Import** window will default to for importing IGRT move data. Click **Browse** to locate directory.

NOTE Data formatted in basic printable ASCII format (i.e., Patient Name, MR Number, Course and Field) can be imported from a patient data management system and from an IGRT system (i.e., correction values), eliminating the need to manually enter this data into the Protura System.

Auto Save Reports Location: This directory is where the Daily Reports and Patient Reports will be saved automatically. Click **Browse** to select directory. This setting is automatically enabled. To disable setting, check the box next to the **Disabled** indicator.

Import Time Threshold: This value (*in minutes*) will be used to compare date and time in IGRT import data to the current system time. If IGRT date and time exceed the threshold value, a warning message will be displayed. This is to reduce the chance of using obsolete IGRT data. Valid values range from 0 to 1500.

NOTE A value of "0" will skip the time threshold check.

Protura Default Speed: This value is the default movement speed for new patients and test procedure. The speed options are Low, Medium and High.

8 Configurations and Settings

Protura Move Delay: This checkbox will delay Protura movement approximately 1.5 seconds after movement is requested. This delay allows time between entering a shift into the software and the actual movement of Protura.

Change Configuration Password: Current password can be changed here. Password field must be at least four (4) characters. *This field accepts up to 30 characters and is case sensitive.*

- Enter **New Password** (*default password is CeePro*).
- Re-enter password into **Confirm New Password**.
- Click **Save**.

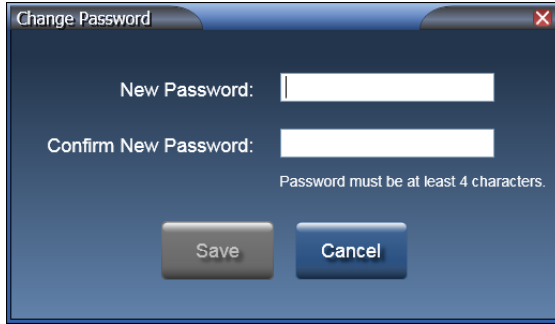

- Before leaving the **Configurations and Settings** window, click **Save** to ensure all changes are saved. To undo any changes made, click **Cancel**. To leave without making changes, click **Close**.

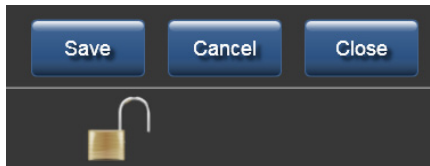

Protura Location Name: This value uniquely identifies this particular instance of the Protura installation. If you have more than one Protura in your department, this is where you would name the particular installation or linac room.

Protura Port: This value is the Protura hardware port number. Valid values range from 1 to 65535. This number is uniquely assigned and should not be changed unless instructed by CIVCO Customer Service.

Protura Address: This value is the Protura hardware IP address. If you need to change the IP address for Protura, please contact CIVCO Customer Service.

Remote Control: This checkbox will allow remote systems to connect to Protura and control it. Ensure at least one IGRT configuration has an Access Key (*refer to Section 8.3 IGRT Coordinate System Configuration/Remote Access Key*) specified prior to defining remote control.

Remote Control IP Address: Value for the Protura workstation IP address to the facility network is selected here. This is the network Protura will communicate with for remote connection.

Remote Control Port: This value is the port number used for connecting remotely. Valid values range from 1024 to 65535.

NOTE

When changing any previously saved configuration value, exit and restart the Protura application to apply changes.

8.2 Couch Pedestal Configuration

The **Couch Pedestal Configuration** tab describes couch translation axes. *Only one configuration can be set up per Protura.*

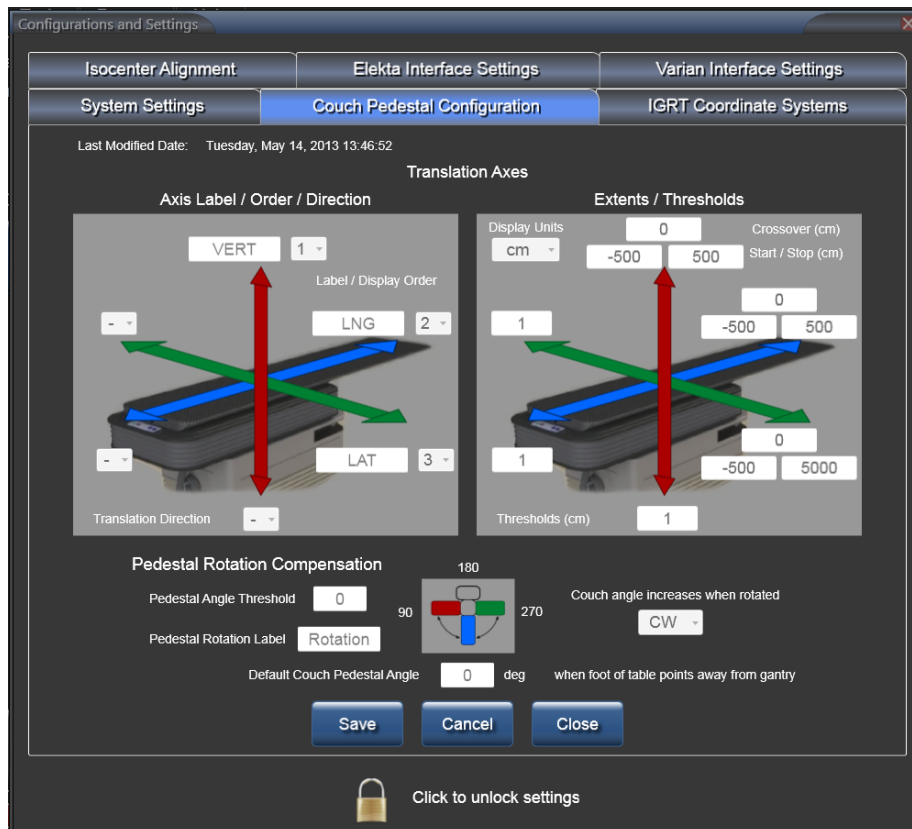

Axis Label / Order / Direction: The left image defines couch labels, display order, and to which direction the positive and negative values refer. *Axis labels accept up to five (5) characters and must be unique.* These values should match your Record and Verify system, linac text description and convention. The order should also be matched to minimize errors.

Extents / Thresholds: The right image defines the range of motion and threshold values. To define the range of motion for an axis, you must enter in three values: **Start**, **Stop** and **Crossover**. Find the values from the linac coordinate convention. The **Crossover** field is the value where the pedestal range restarts from zero again. Axis threshold value will be used to display a warning when one or more of the current Couch Pedestal Values, included in an IGRT import file or manually entered, differ from the previous move for the course by more than the threshold value defined. **Display Units** drop down list contains **cm** and **mm** values and this determines the unit of measure.

For Example: a Start of 9,000 with a Stop of 3,000 and a crossover of 10,000 has a linear axis defined to be 9,000 to 10,000, 0 to 3,000.

NOTE

A value of "0" will skip the threshold check.

8 Configurations and Settings

Pedestal Rotation Compensation: Defines Pedestal Angle Threshold, Default Couch Pedestal Angle and Angle Rotation.

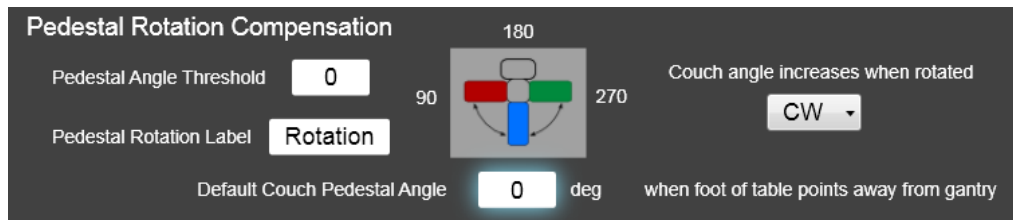

Pedestal Angle Threshold: This value (*specified in degrees*) will be used to display a warning when the current Couch Pedestal Value, included in an IGRT import file or manually entered, differ from the previous move for the course, by more than the threshold value defined.

NOTE

A value of "0" will skip the threshold check.

Pedestal Rotation Label: This should match linac text description and convention. *This value accepts up to eight (8) characters.*

Couch angle increases when rotated: Choose from CW (*clockwise*) or CCW (*counter-clockwise*) for angle calculation. Verify intended angle direction is displayed correctly in image.

Default Couch Pedestal Angle: Choose appropriate longitudinal angle for pedestal orientation.

- Before leaving the **Configurations and Settings** window, click **Save** to ensure all changes are saved. To undo any changes made, click **Cancel**. To leave without making changes, click **Close**.

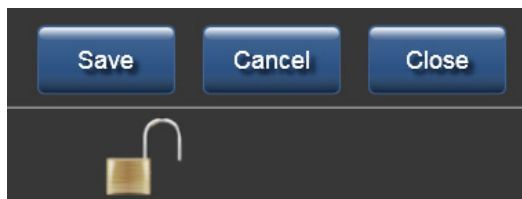

NOTE

When changing any previously saved configuration value, exit and restart the Protura application to apply changes.

8.2.1 Couch Pedestal Configuration Relationship

Current Couch Pedestal Location (left image) are displayed in the following order: **Vert, Long** and **Lat**. This display order is defined in **Configurations and Settings**. (right image)

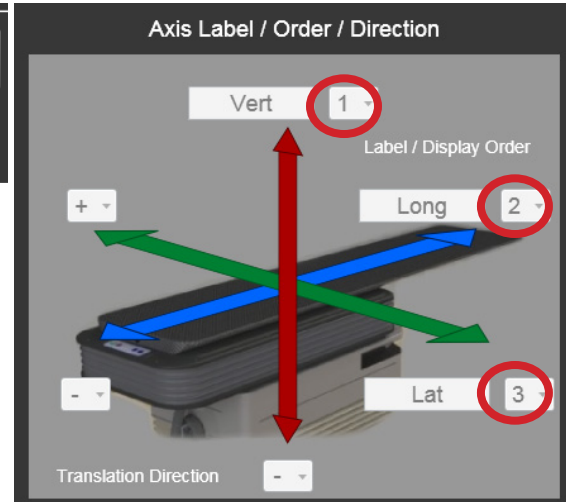
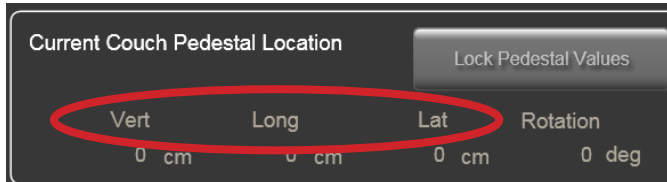

From **Tools** menu,
click **Configure...**
click **Couch Pedestal Configuration**.

Unlock the settings.

Change Display order for Vert from 1 to 2, Long automatically changes to 1.

Change Display order for Long from 1 to 3 and Lat automatically changes to 1.

Click **Save**.

Changes are displayed on the main window:

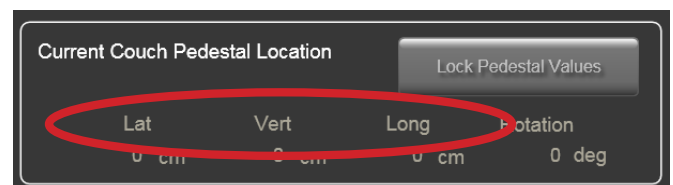
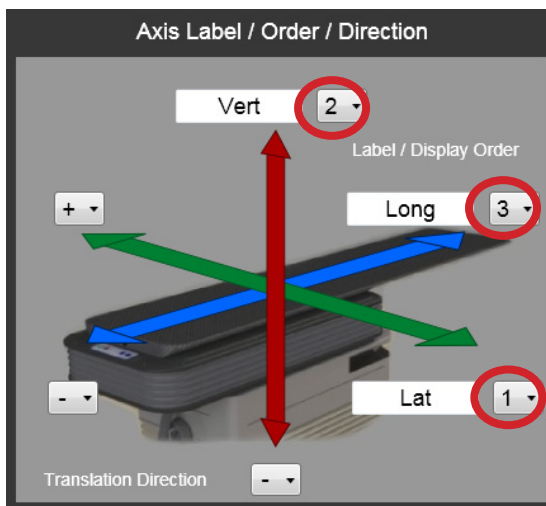

NOTE

When changing any previously saved configuration value, exit and restart the Protura application to apply changes.

8.3 IGRT Coordinate System Configuration

IGRT Coordinate Systems tab is where one or more IGRT Coordinate Systems are defined. The IGRT Coordinate System definition can be configured to match treatment and imaging equipment setup, enabling easy entry of IGRT move data.

- Select different **IGRT Coordinate System** from drop list.
- Create **new** system, or **edit** or **delete** an existing system.
- Select a current system from the drop list to view configuration settings.

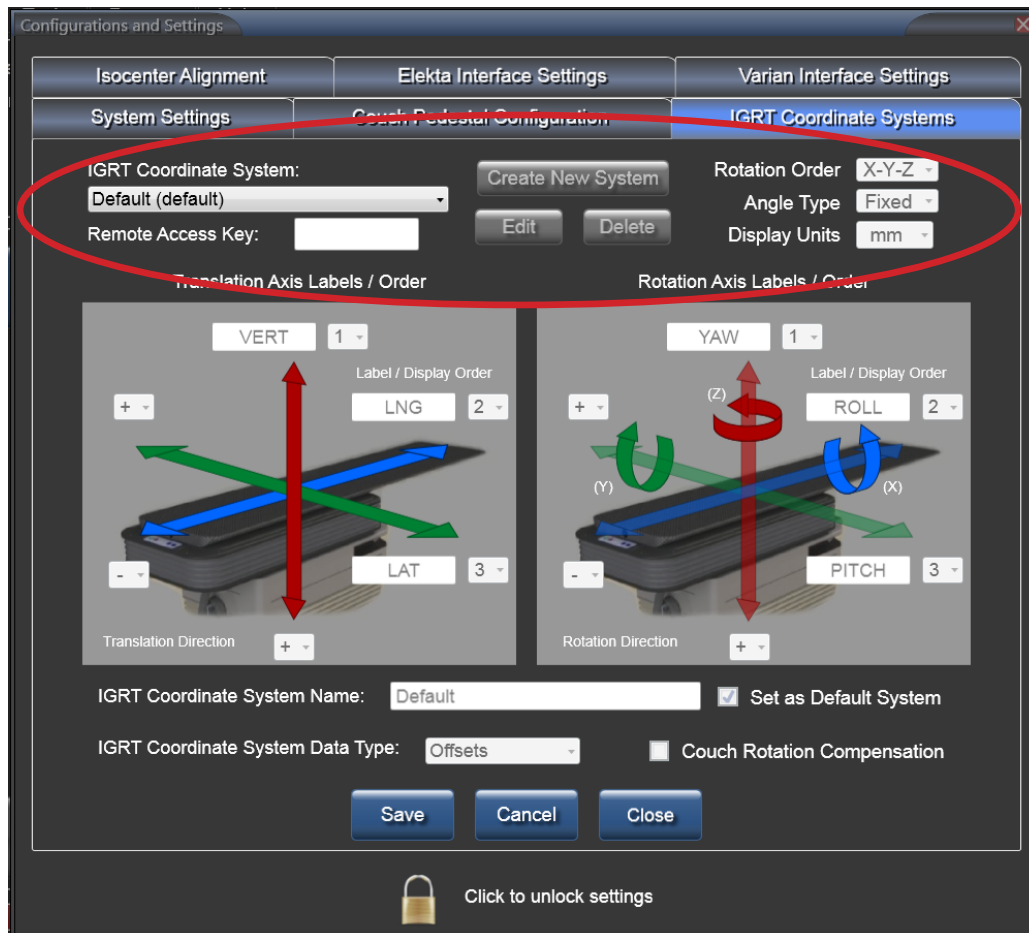

WARNING



- *The use of an incorrect IGRT Coordinate System can lead to mistreatment. Care should be taken to ensure the correct IGRT Coordinate System is used for each patient. For example, the user may rely on an optical based IGRT system and periodically perform a CBCT for alignment. If the two IGRT systems have different coordinate systems or outputs, the user must make sure the correct system is selected for treatment.*

8 Configurations and Settings

IGRT Coordinate System: A new IGRT Coordinate System can be created or a current system can be edited or deleted.

CREATE NEW SYSTEM:

Click **Create New System** to create a new system.

Enter required data.

Click **Save** once all information is completed.

EDIT:

Select system from drop down list.

Click **Edit** to change configuration settings.

Click **Save** once all information is completed.

DELETE:

Select the IGRT Coordinate System from drop down list to be deleted.

Click **Delete**.

A window will display to confirm deletion. Click **OK**.

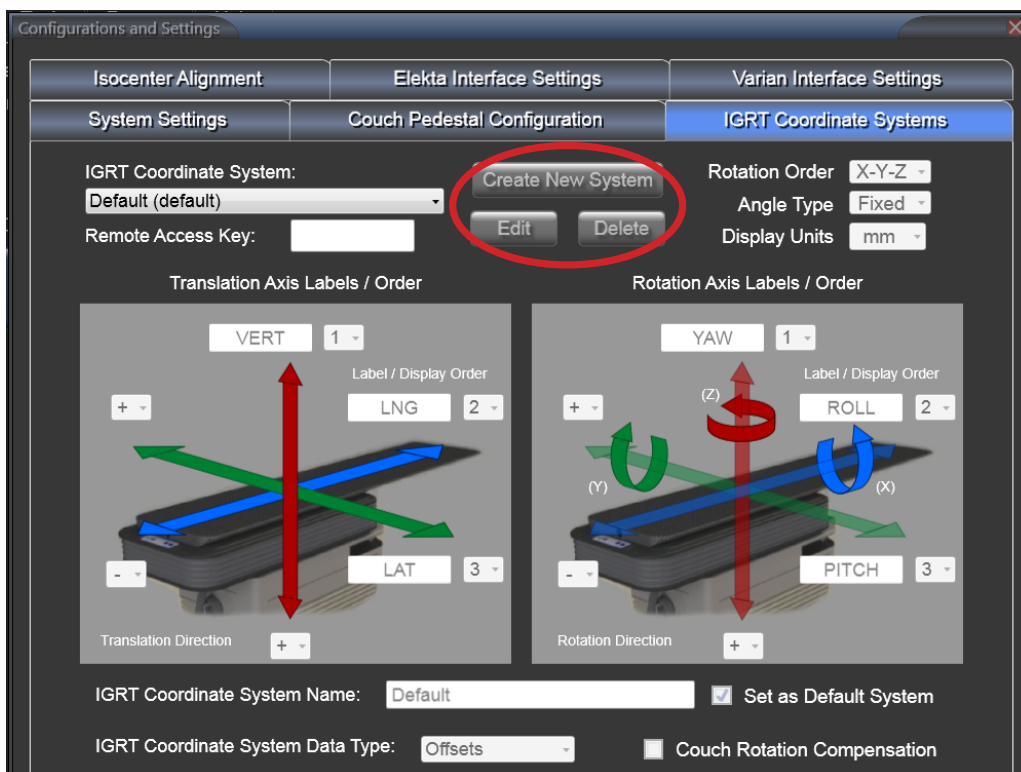

Remote Access Key: Allows an approved remote system to connect with Protura. Move data will be reported using this IGRT configuration. *This field accepts up to 10 characters and must be unique.*

Rotation Order: Determines the order of axis rotation. Drop down list contains all **X-Y-Z** value combinations.

Angle Type: Determines the type of angle. Drop down list contains **Fixed** and **Euler** values.

Display Units: Determines the unit of measure. Drop down list contains **cm** and **mm** values.

Translation Axis Labels / Order and **Rotation Axis Labels / Order:** Values can be entered into axis labels, display order Translation Direction can be selected. *Axis labels accept up to five characters and must be unique.*

IGRT Coordinate System Name. *This field accepts up to 20 characters and must be unique.* Default system can be set by selecting checkbox by **Set as Default System**.

NOTE

Changing the **IGRT Coordinate System Name** requires a restart of Protura to see the new name.

8 Configurations and Settings

IGRT Coordinate System Data Type: Drop down list contains **Offsets** and **Absolute** values. When **Offsets** data type is selected, values entered in **Proposed Values** section of the main window will be relative to the current Protura position. When **Absolute** data type is selected, values entered in **Proposed Values** section of the main window will indicate absolute coordinate values for Protura movement.

Couch Rotation Compensation: Checkbox determines if Protura shifts will be applied in relation to room coordinates or in relation to pedestal coordinate frame when pedestal is in a rotated position. Check the box if IGRT data source is compensating for couch pedestal rotation. When checkbox is not selected, Protura will compensate for the couch pedestal rotation.

- Before leaving the **Configurations and Settings** window, click **Save** to ensure all changes are saved. To undo any changes made, click **Cancel**. To leave without making changes, click **Close**.

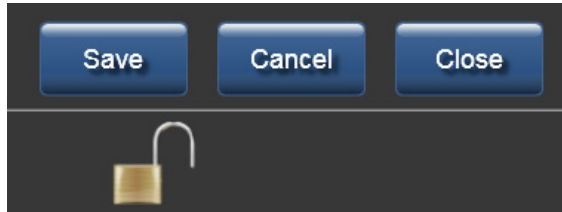

NOTE

When changing any previously saved configuration value, exit and restart the Protura application to apply changes.

8.3.1 IGRT Coordinate System Relationship

This example illustrates how to change prompts on the main window for Proposed Values. Axis labels can be changed here.

Proposed Values (left image below) are displayed in the following order: VERT, LNG, LAT, YAW, PITCH, and ROLL. This display order is defined in **Configurations and Settings** (right image below).

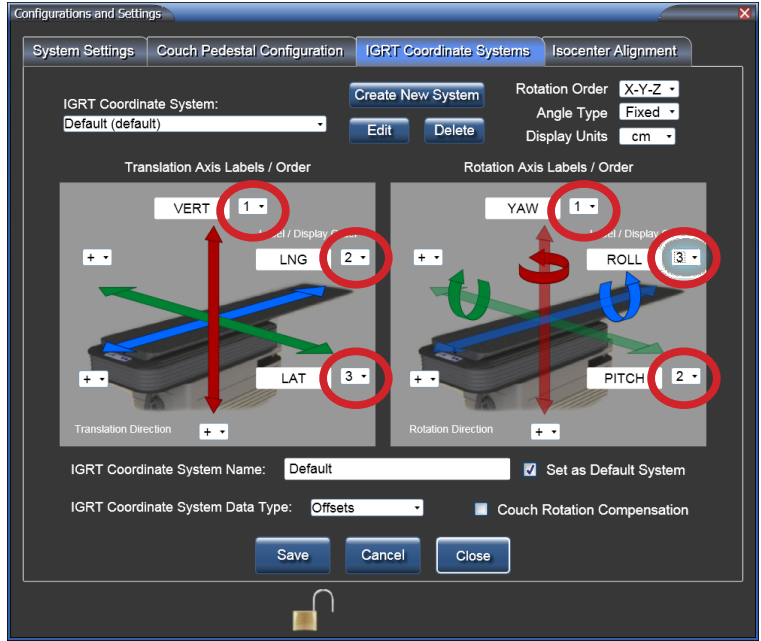
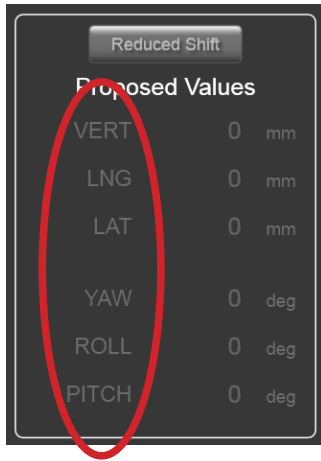

From **Tools** menu, click **Configure...**
 click **IGRT Coordinate Systems**.
Unlock the settings.
 Select **IGRT Coordinate System** from drop list, click **Edit**.

Change Display order for VERT from 1 to 3, LAT automatically changes to 1.
 Change Display order for ROLL from 3 to 2 and PITCH automatically changes to 3.
 Click **Accept System**. Click **Save**.
 Changes will be displayed on the main window:

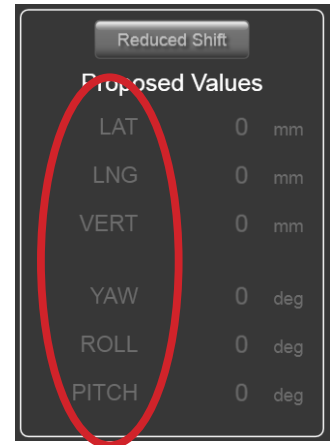
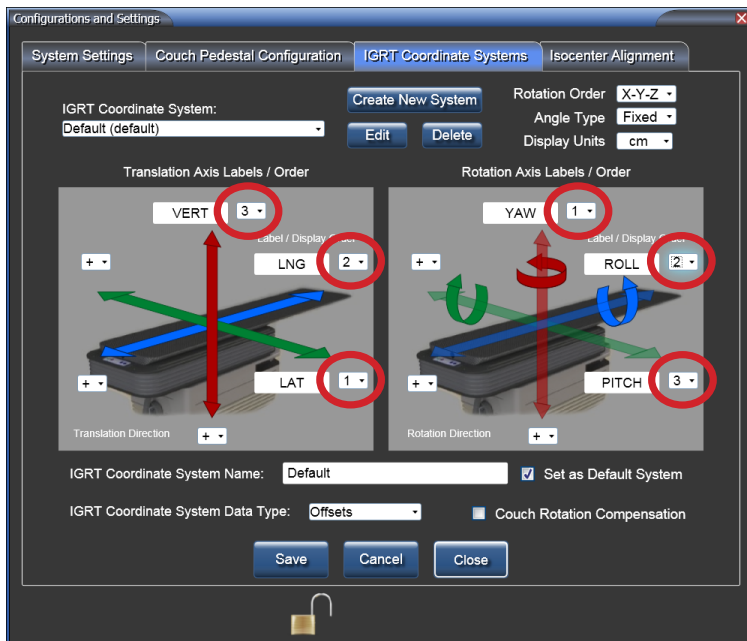

NOTE When changing any previously saved configuration value, exit and restart the Protura application to apply changes.

8.3.2 Override IGRT Data Type (Absolute or Relative Coordinates)

Current System Settings can be overridden for the following attributes on a per patient and per treatment basis. **IGRT Coordinate System** Data types are Absolute or Offset Coordinate values.

NOTE Relative will switch the IGRT system to Offsets.

WARNING



- When a relative move is interrupted, the **Proposed Values** do not reflect the remaining move position. Users must confirm the patient is in the correct position prior to starting treatment.

IGRT Data type defines whether or not the coordinates in the **Proposed Values** fields are absolute values (from **Zero Position**) or relative to the current position of Protura hardware.

1. From the **Tools** menu, click **Override IGRT Settings**.
2. IGRT Data types are listed above the divider. The current data type is indicated by a check mark. Select the IGRT Data type to use.
3. Confirm the main window reflects the updated IGRT Data type in Patient Move Panel and status bar.

NOTE Data type selection is typically made in the configuration section of Protura (refer to Section 8.3 IGRT Coordinate System Configuration).

WARNING



- Overriding system setting should be carefully considered and performed only by trained users of the system.

8.4 Isocenter Alignment

Displays the Alignment Data entered on the main window in read-only format (refer to Chapter 3 Alignment).

Isocenter Alignment tab can be used as a quick reference for retrieving pedestal alignment information.

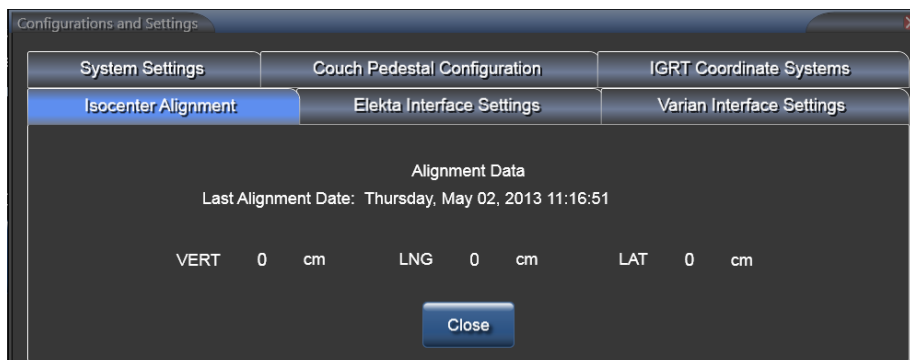

NOTE When changing any previously saved configuration value, exit and restart the Protura application to apply changes.

8.5 Varian Interface Settings

Varian Interface Settings tab is where the Varian Interfaces are defined. The **4DTC Interface** checkbox should be checked if Protura is installed on a Varian linac with Auxiliary Device Interface (ADI).

If ARIA is the record and verify system being used, leave **MOSAIQ** checkbox unchecked.

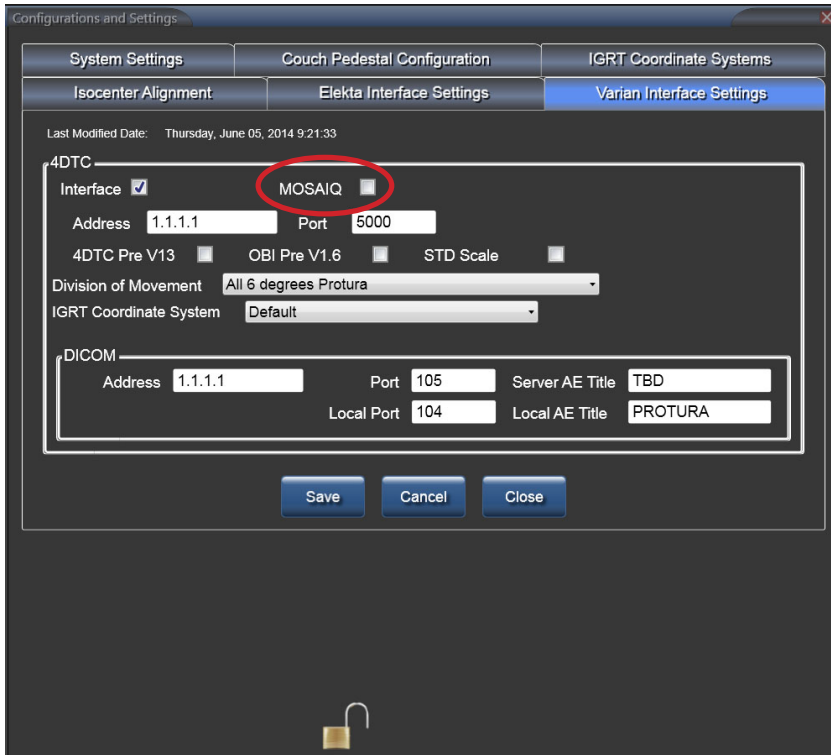

If MOSAIQ record and verify system is being used, **MOSAIQ** checkbox must be checked.

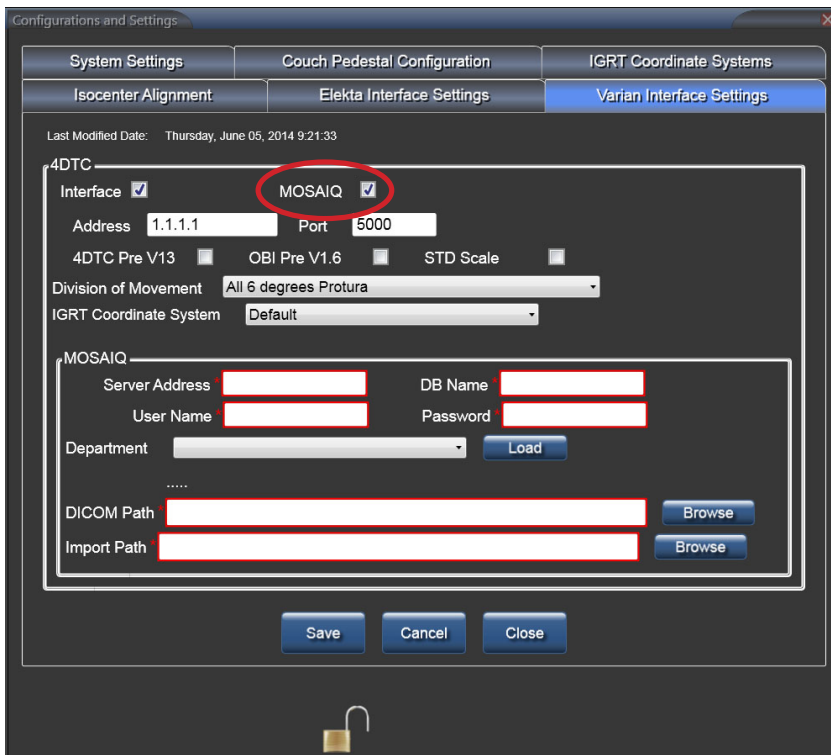

WARNING



- Execution of QA tests is required following any updates to Varian 4DTC, OBI, ARIA, or MOSAIQ systems. Verify shift values calculated by Protura match the shifts generated in the OBI System.

8.5.1 Varian 4DTC Interface

4DTC Address (or Varian MICAP), Port, and DICOM or MOSAIQ information must be added. With Varian 4DTC Interface, enabled, the following things occur:

- The interface will allow the Protura System to connect to the Varian ADI as a 3rd party auxiliary system.
- This connection will provide Protura with Patient Open, Mode Up, Clear Fields, Clinac Ready options.
- Will allow Protura to Authorize treatments and Request Pedestal Moves.
- The **4DTC Pre V13 checkbox** must be selected when using Varian 4DTC versions prior to Version 13. This allows Protura to accurately authorize treatment fields in the Varian environment when changing 4DTC versions.
- The **OBI Pre V1.6 checkbox** must be selected when using Varian OBI versions prior to Version 1.6. This allows Protura to accurately import and apply shifts as defined in the OBI system. The Pitch and Roll sign conventions (+/-) will change with OBI Version 1.6 in the Varian environment. Therefore, the **Protura IGRT Coordinate System** must also be updated when changing the selection of this checkbox. Refer to Section 8.3 IGRT Coordinate System Configuration.
- The **STD Scale checkbox** must be selected when using Varian Standard Scale. This allows Protura to accurately import the pedestal location when using Varian Standard Scale.
- Right linac light is green when connection is enabled.

Version: Aligned: 5/2/2013 Linac Protura connected

- Both linac lights are green when Protura has found registration files.

Version: Aligned: 3/26/2013 Linac Protura connected

- Left linac light is yellow and right linac light is green when Protura is transferring data.

Version: Aligned: 3/26/2013 Linac Protura connected

- Left linac light is blue and right linac light is green when linac is connected with a non-Protura patient is loaded.

Version: Aligned: 5/22/2013 Linac Protura connected

- Right linac light is red when linac is not connected.

Version: Aligned: 5/2/2013 Linac Protura connected

- Left linac light is red when DICOM is not connected.

Version: Aligned: 5/2/2013 Linac Protura connected

WARNING



- Verify connection to the correct 4DTC System.

8 Configurations and Settings

Division of Movement: This is a system setting and not for individual patients. Three settings are available; **All 6 degrees Protura**, **Translation Pedestal / Rotation Protura**, or **Translation and Yaw Pedestal / Pitch and Roll Protura**. Once Protura is connected to the Varian System and shift values are populated in the **Proposed Values** fields, the **Division of Movement** setting will determine which system executes the specified shift values when **Move** is selected.

- **All 6 degrees Protura** will send all six shift values to the Protura hardware.
- **Translation Pedestal / Rotation Protura** will split shifts between the Protura hardware and pedestal move request to the 4DTC.
- **Translation and Yaw Pedestal / Pitch and Roll Protura** will split shifts between the Protura hardware and pedestal move request to the 4DTC.

NOTE

When selecting one of the split shift options, Protura is not notified by 4DTC if or when the pedestal executes requested shift. The user should follow workflow defined in *Section 6.3 Protura Workflow - Varian Integration with Pedestal Shifts*.

When making secondary shifts through the Protura software, the additional shifts will be performed as **All 6 Degrees Protura** with no shifts sent to the pedestal.

IGRT Coordinate System: This will define the coordinate frame for the Varian Interfaced System.

DICOM: This connection information is required for Protura to access registration data sent from the OBI when configured for use with ARIA record and verify system. This allows Protura to calculate the required correctional shift values. **Address, Port, Server AE Title, Local AE Title, and Local Port** must be entered to connect Protura to the ARIA record and verify system.

MOSAIQ: This connection information is required for Protura to access registration data sent from the OBI when configured for use with MOSAIQ record and verify system. This allows Protura to calculate the required correctional shift values. **Server Address, DB Name, User Name, Password, Department, DICOM Path and Import Path** must be entered to connect Protura to the MOSAIQ record and verify system.

8.6 Elekta Interface Settings

Elekta Interface Settings tab is where the Elekta interfaces are defined. This interface will provide pedestal location and course/field information for the currently loaded patient.

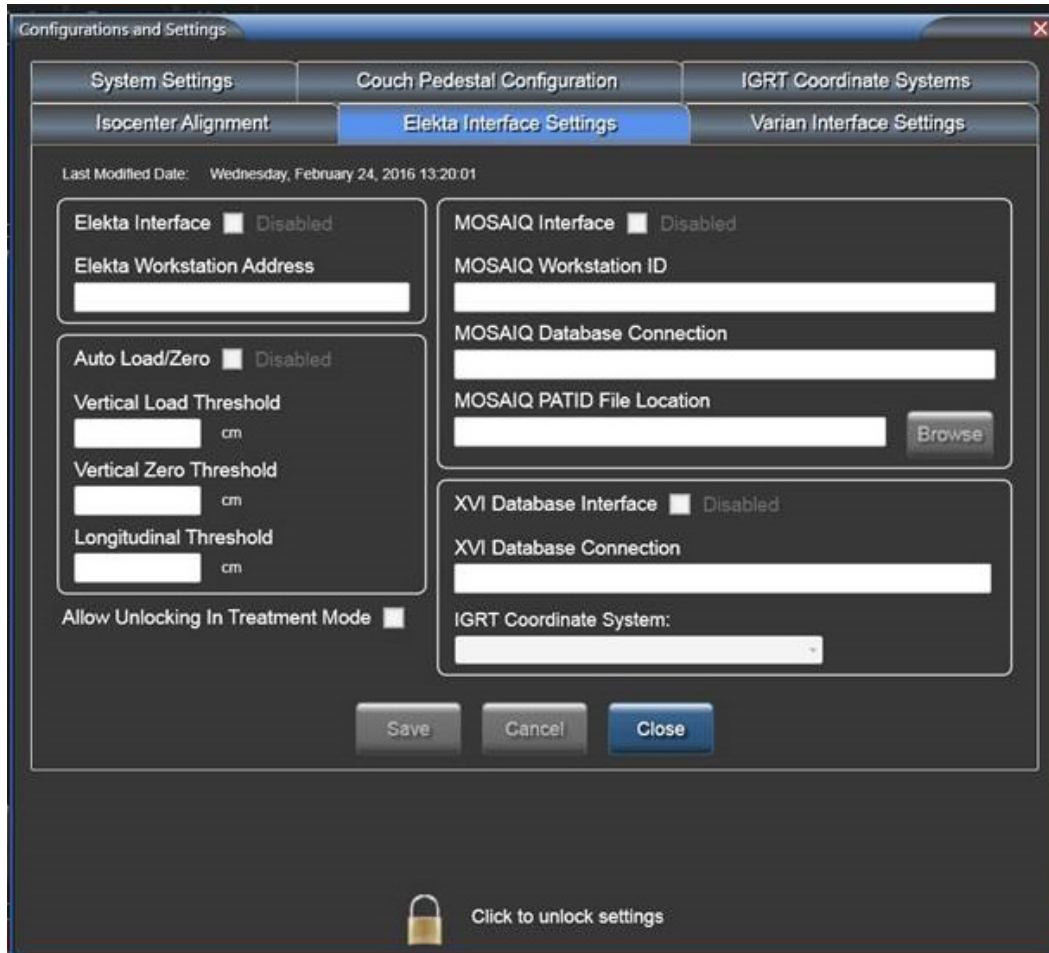

8.6.1 Elekta Interface

When the **Elekta Interface** checkbox is **Enabled**, the following things occur.

- Couch pedestal values are automated with current pedestal locations when a patient record is open, pedestal values are unlocked and Protura is not in the **Load / Unload** position.
- System will automatically answer **Yes** to a successful move when the linac signals a treatment segment has started.
- The **Unlock** option will be displayed when the linac interrupts a treatment segment.
- An optional interface is active between the Touch Guard System and the Protura System so when the Touch Guard is activated, Protura movement stops.
- Linac button is green when connection is enabled.



WARNING



- When Linac status button is red, users must ensure the Couch Pedestal Values are correct.

Elekta Workstation Address: Contains the IPv4 address for which Protura will receive communication messages from the Elekta linac. *This field accepts up to 15 characters.*

Auto Load / Zero: Check box only if Elekta interface is enabled.

WARNING



- When changing Auto Load/Zero configuration, verify auto movement system functioning with desired cross-over thresholds based on site treatment protocols. Failure to do so could result in unexpected Protura movement.

Vertical Unload Start Threshold: The field precision is 0.1mm. Once the pedestal moves away from the linac and across the Longitudinal Load threshold the Vertical Load threshold moves Protura to **Load / Unload** position.

Vertical Zero Threshold: The field precision is 0.1mm. While the pedestal is away from the linac and is across the Longitudinal Load threshold the Vertical Zero threshold moves Protura to **Zero Position**.

Longitudinal Load Threshold: The field precision is 0.1mm.

Allow Unlocking in Treatment Mode: Check box only if Elekta interface is enabled. User is allowed to unlock Protura to exit treatment mode when enabled.

NOTE

Pedestal location is not automatically updated during alignment procedure.

When Touch Guard is configured, the **Load / Unload** button and **Zero Position** button on Protura are disabled. These motions remain available in Protura software.

If connection with the Touch Guard system is lost, activation of the Touch Guard does not prevent Protura movement.

8.6.2 MOSAIQ Interface

When the **MOSAIQ Interface** checkbox is **Enabled**, Protura is able to have “read access” to the MOSAIQ database application directory. This interface allows Protura to monitor the MOSAIQ workstation sending treatment data to detect patient loading and unloading when the pedestal values are not locked. When a patient is loaded on the MOSAIQ workstation, the patient will be automatically loaded onto the Protura System if they already exist. If they do not exist on Protura then the database will be queried to get the patient information and a patient record will be created.

MOSAIQ Workstation ID: Contains the MOSAIQ workstation unique ID number. *This field accepts up to 10 characters.*

MOSAIQ Database Connection: Defines connection string necessary to communicate with MOSAIQ database. *This field accepts up to 255 characters.*

MOSAIQ PATID File Location: Defines MOSAIQ “application directory”.

NOTE

When interfaced with the MOSAIQ System, any patient record automatically created in the Protura database will be automatically deleted at the end of patient treatment only if the Protura was not used to correct patient’s treatment position (i.e., no shift information is saved for patient record).

8.6.3 XVI Database Interface

When the **XVI Database Interface** checkbox is **Enabled**, Protura is able to have read access to the XVI database. When **Import** is selected, the following will occur:

- Protura will display, in the **Proposed Values** fields, the new shift data for the loaded patient. This data should be verified against the XVI data. The **Move** button must be selected to accept the **Proposed Values**.

NOTE There is an indicator change from (+) to (-) or from (-) to (+) between the XVI System and the Protura System.

XVI Database Connection: Defines the connection string necessary to communicate with the XVI database. *This field accepts up to 255 characters.*

IGRT Coordinate System: Defines the coordinate frame for the XVI Interfaced System.

WARNING



- *Execution of QA Test Localization Accuracy is required for each IGRT system when changing the system configuration. Do not operate Protura in the event of errors.*

NOTE When changing any previously saved configuration value, exit and restart the Protura application to apply changes.

8.7 Remote Control Settings

The Protura system can be configured to allow an IGRT Coordinate System to remotely control Protura workflows.

1. Enable and identify the Remote Control system.
2. In the **System Settings** tab in **Configurations and Settings**, select the Remote Control checkbox.
3. Enter the Remote Control IP Address and Control Port.

Remote control requires a **Remote Access Key** and is entered in the **IGRT Coordinate Systems** tab in **Configurations and Settings**. (Refer to Section 8.3 IGRT Coordinate System Configuration).

NOTE When AlignRT is used as the remote system, ensure the IGRT Coordinate System Data Type is set to **Offsets**. (Refer to Section 8.3 IGRT Coordinate System Configuration).

Prior to launching the IGRT system software, ensure the Protura System is powered on and launched.

WARNING



- *Execution of QA Test Localization Accuracy is required for each IGRT system when changing the system configuration. Do not operate Protura in the event of errors.*

9 Backup

1. From the **Configuration** window determine the location of patient data for Protura.
2. Open **My Computer** and navigate to the patient data location.

If your site has an MR number format containing unfriendly file system characters, you may end up with multiple <MR Number>'s appearing the same (*refer to the top three files in the illustration below*).

Name ▲	Size	Type
123-456-78915~1e436a61-133c-4f73-a6e7-08cda9d2ac2d		File Folder
123-456-98715~3ceb7fc4-7022-4208-952c-d41b4505e840		File Folder
123-456-98715~45cf2b47-854c-4901-97bb-160ae250f7d5		File Folder
123-856-8954Charles B~a28aeaaf-b2d0-4f3a-946b-59153d1c9a76		File Folder
467-167-1287 Craig C~bac14661-240e-4327-ab93-b40c41d39d41		File Folder
546-897-36968~076ed0dd-167c-4a5f-bcab-3df66250e75d		File Folder
SystemsList.config	1 KB	CONFIG File

To verify the correct patient for backup, close Protura application, open directory and view PatientData.xml file using a web browser.

3. **Select** the directories and **copy** them onto a network drive for backup or onto a CD-R to burn on your system.

To restore patients from backup location: prior to copying the entire patient directory, ensure patient is not open in software and remove existing version in the patient data directory.

10 System Specifications

10.1 Protura Specification

Classification	Class 1 Type B
Operating Voltage	48V DC
Operating Current at Max Load	7.4 Amp
Dimensions	(1340 x 619 x 206 mm)
Weight	90 kg (198 lbs.)
Storage Temperature	-20° C to 70° C

10.2 Power Supply Specifications

Operating Voltage	100 - 130V AC with appropriate fuse, 60 Hz 220 - 240V AC with appropriate fuse, 50 Hz
Output Voltage	48V DC \pm 2 V
Power Consumption ¹	450 VA
Peak Supply Current ²	9.9 Amp
Fuses	For 115V AC network voltage: 8 A T (IEC) For 230V AC network voltage: 4 A T (IEC)
Operating Temperature	5° C to 35° C
Dimensions (L x W x H)	483mm x 340.5mm x 135.5mm (19" rack, 3 U, with handles and rubber feet)
Weight	7.2 kg (16 lbs.)
Material of Case	Aluminum
Storage Temperature	- 20° C to 85° C
Max. Relative Humidity	<70%

¹ with maximum load

² for 100 ms maximum, short circuit protected

10.3 Cable Specifications

P/N	Function	Type
EWIETHNET101	Communication from Protura to PC	Cat 5 shielded crossover cable, 100' long
20XPIPC3	48VDC supply to Protura from PS	4 conductor industrial cable, 40' long
206X051	Communication and 48VDC to Protura	7 conductor coiled hybrid cable, 3' long

10.4 Test/Emission Specifications

TEST STANDARD / TEST METHOD	TEST	EMISSIONS CLASS AND GROUP / IMMUNITY TEST LEVEL
IEC 60601-1-2 / CISPR 11:2009/ AMD1:2010	Radiated Emissions	Class A Group 1
IEC 60601-1-2 / CISPR 11:2009/ AMD1:2010	Conducted Emissions	Class A Group 1
IEC 60601-1-2 / IEC 61000-3-2:2005/ AMD2:2009	Harmonic Current Emissions	Class A
IEC 60601-1-2 / IEC 61000-3-3:2013	Voltage Fluctuations Emissions	All parameters
IEC 60601-1-2 / IEC 61000-4-2:2008	Electrostatic Discharge Immunity	8kV Air / 15 kV Contact
IEC 60601-1-2 / IEC61000-4-3:2006/ AMD2:2010	Radiated RF Electromagnetic Fields Immunity	Per IEC 60601-1-2 Ed. 4
IEC 60601-1-2, 8.10 / IEC 61000-4- 3:2006/ AMD2:2010	Immunity to proximity fields from RF wireless communications equipment.	Per IEC 60601-1-2 Ed. 4
IEC 60601-1-2 / IEC 61000-4-4:2012	Electrical Fast Burst Transients and Bursts Immunity	Per IEC 60601-1-2 Ed. 4
IEC 60601-1-2 / IEC 61000-4-5:2005	Surge Immunity	Per IEC 60601-1-2 Ed. 4
IEC 60601-1-2 / IEC 61000-4-6:2013	Conducted Disturbances, Induced by RF Fields Immunity	Per IEC 60601-1-2 Ed. 4
IEC 60601-1-2 / IEC 61000-4-8:2009	Power Frequency Magnetic Fields Immunity	Per IEC 60601-1-2 Ed. 4
IEC 60601-1-2 / IEC 6100-4-11:2004	Voltage Dips Immunity	Per IEC 60601-1-2 Ed. 4
IEC 60601-1-2 / IEC 61000-4-11	Voltage Interruptions Immunity	Per IEC 60601-1-2 Ed. 4

11 System Maintenance

11.1 Touchscreen Configuration

For Planar Touchscreens:

Consult Touchscreen CD for additional features.

1. Click **Start** and point to **All Programs, TouchKit, Configure Utility**. *Administrative password may be required.*
2. Select **Tools** tab, **4 points calibration** and follow on-screen instructions.
3. Click **OK** when complete.

Default for touchscreen is set for a beep to sound with each touch. To turn beep sound off:

1. Select **Settings** tab.
2. Click **Beep On Touch, Beep On Release, and Beep From Sound Card** checkboxes to disable.
3. Click **OK** when complete.

Default for touchscreen is set to "Enable Auto Right-Click." To disable:

1. Select **Settings** tab and click **Option**.
2. Clear **Enable Auto Right Click** checkbox.
3. Click **Apply**, then click **OK**.

For Elo Touchscreens:

1. Click **Start**, then **Control Panel Elo Touchscreens**.
2. Select **Align** button.
3. Select **OK**.

Default for touchscreen is set for a beep to sound with each touch. To disable:

1. Select **Sound** tab.
2. Click **Beep** to disable.
3. Click **OK**.

11.2 Quality Assurance Test Procedure

Periodic Protura Quality Assurance is essential to prevent mechanical and configuration errors. Mechanical errors could result in incorrect positioning. Configuration errors pertain to inadvertent changes to information in the Protura System and/or IGRT Configuration Settings. The following section outlines the Quality Assurance Test Procedure for validating elements of the localization process.

NOTE

Quality Assurance should be done quarterly.

Quality Assurance should be repeated after every software upgrade or any change to a system that affects localization accuracy.

11.2.1 Mechanical Maintenance

The Protura system includes a **Test Procedure** (refer to *Chapter 4 Test Procedure*) which commands the Protura robotic couchtop through a defined range of motion. Execution of this **Test Procedure** will ensure the robotic gears and motors are lubricated and functioning properly. The automated test will take several minutes to run based on the default Protura move speed.

11.2.2 Isocenter Alignment

The Protura system features a virtual pivot point. Any rotational corrections to the couch position are executed with isocenter as virtual pivot / reference point. Protura alignment assures the virtual point will be calculated properly with respect to isocenter. The Protura software includes an **Align Pedestal Configuration** which is used to assign a known Protura coordinate position to the pedestal location (*refer to Chapter 3 Alignment*). This procedure will take 10 to 15 minutes to complete.

11.2.3 Localization Accuracy

The Protura Robotic Couch System is intended to provide sub millimeter patient positioning accuracy. Quality Assurance should be performed to ensure the system is functioning within this tolerance.

CIVCO recommends the following two methods for inspecting position accuracy. The first test verifies Protura moved to known locations. The second test verifies Protura motion while simulating patient repositioning. Both tests are verifying a phantom moved to an intended location, so one or both test methods can be used for Quality Assurance.

1. Verify Protura moves to known locations.

- Make measured shifts shown below with phantom on couchtop. Make each shift as a separate move and document the IGRT output.

Measured Shifts:

SHIFT	LONGITUDE	LATITUDE	VERTICAL	ROLL	PITCH	YAW
SHIFT 1	+50	0	0	0	0	0
SHIFT 2	-50	0	0	0	0	0
SHIFT 3	0	+25	0	0	0	0
SHIFT 4	0	-25	0	0	0	0
SHIFT 5	0	0	+25	0	0	0
SHIFT 6	0	0	-25	0	0	0
SHIFT 7	0	0	0	+2.5	0	0
SHIFT 8	0	0	0	-2.5	0	0
SHIFT 9	0	0	0	0	+2.5	0
SHIFT 10	0	0	0	0	-2.5	0
SHIFT 11	0	0	0	0	0	+2.5
SHIFT 12	0	0	0	0	0	-2.5
SHIFT 13	0	0	0	+1.0	+1.0	+1.0
SHIFT 14	0	0	0	-1.0	-1.0	-1.0

11 System Maintenance

2. Verify Protura moves with simulated patient repositioning.

Validate CT image acquisition and TPS marker coordinate import:

1. CT scan phantom (1 mm slices or better of CIVCO Alignment Block or one of your choice) in the null position.
2. Import scans into treatment planning software.

Protura shifts and rotations applied:

1. Launch Protura.
2. Create new QA patient (or open an existing QA patient).
3. Make sure IGRT system loaded in Protura represents IGRT system you are using during QA Procedure.
4. Enter shifts and rotations generated in IGRT system into Protura.
5. Select **Move**.
6. Verify shifts and rotations bring phantom to isocenter within acceptable tolerance levels (+/- 1mm, +/- 0.2 degree).

11.3 Reprocessing

WARNING



- *Users of this product have an obligation and responsibility to provide the highest degree of infection control to patients, coworkers and themselves. To avoid cross-contamination, follow infection control policies established by your facility.*

Wipe all surfaces with common germicidal or antiseptic wipe, such as alcohol. Take care when cleaning device to ensure no fluids come in contact with internal robotic components.

NOTE

Moisture and cleaning fluids can cause malfunctioning of the robotics system.

11.4 Maintenance

Device has no user serviceable parts. Opening shell and skirt (bellows) can lead to serious injury, including crushed limbs and electric shock which could result in death. Only trained service technicians and installers should ever open the system. Contact CIVCO Customer Service.

WARNING



- *Inspect device prior to use for signs of damage and general wear.*
- *Device should not be opened or serviced during operation or while power is plugged in.*
- *Device should only be serviced by authorized personnel.*

12 System Messages



Warning Symbol



Error Symbol



Information Only Symbol



Confirmation Symbol

Message	Definition
Accuracy Error. Failed to move to target location with sub-millimeter precision. Verify patient position. Treat at current location or initialize and move back to zero to try again?	If Treat button is selected, Ready to Authorize or Ready for Treatment dialog will be shown, depending on configuration. If Initialize button is selected, message dialog box will close and Protura will return to main window.
Alignment Validation Error(s). The following alignment validation errors exist and must be corrected prior to saving the values:	Informs user one or more validation values are incorrect. When OK is clicked, this window closes.
Change IGRT Data Type. The selected IGRT Coordinate System's Data Type is currently Absolute and will be changed to Offsets.	If OK is clicked, the selected IGRT Coordinate System Data Type will be changed to Offsets. If Cancel is clicked, this window closes without change.
Configuration Settings Exist. Importing configuration settings will overwrite the existing configuration settings and require the Couch Pedestal to be aligned. Do you want to continue?	Informs user existing configuration settings will be overwritten by the import. If Yes is clicked, this window closes, the configuration import process continues, and the Configuration Password window displays. If No is clicked, this window is closed and the configuration import process aborts.
Configuration Validation Warning(s). The following configuration parameters do not contain values. These values must be set before the system can be used. Would you like to continue?	Informs user one or more configuration parameters are incorrect. The incorrect configuration fields are displayed. If Yes is clicked, this window closes and the data present is written to the configuration file. If No is clicked, this window is closed and the Configuration window remains open.
Configuration Validation Error(s). The following configuration validation errors exist and must be corrected prior to saving the values:	Informs user one or more configuration values are incorrect. The incorrect configuration fields are displayed. When OK is clicked, the Save is cancelled.
Configuration Validation Error(s). The following configuration validation errors exist and must be corrected prior to saving the values:	Informs user one or more Elekta Interface configuration values are incorrect. When OK is clicked, focus is returned to the first field in tab order on the External Interface Settings tab which contains an error. Save and Cancel remain enabled.

Message	Definition
Configuration Validation Error(s). The following configuration validation errors exist and must be corrected prior to saving the values:	Informs user one or more Varian 4DTC, Varian DICOM or Varian MOSAIQ Interface configuration values are incorrect. When OK is clicked, focus is returned to the first field in tab order on the Varian Interface Settings tab which contains an error. Save and Cancel remain enabled.
Confirm. Protura will move to Zero Position. Click OK to continue.	Informs user of a pending move to Zero Position . If OK is clicked, Protura will move to Zero Position .
Confirm Patient and Pedestal Location. Confirm correct patient is loaded and the pedestal is in correct position.	If Continue is clicked, this window is closed, couch pedestal is locked and application stops monitoring MOSAIQ PATID file. If Cancel is clicked, the couch pedestal is not locked and the application resumes monitoring MOSAIQ PATID file. If Load Last Patient is clicked, the last patient is loaded, couch pedestal is not locked and the application resumes monitoring MOSAIQ PATID file.
Confirm Pedestal Location. Confirm pedestal is in original position. If the pedestal has moved, move it back to the original location. Click Cancel to enter in the new pedestal location.	If OK is clicked, message window Continue to Destination? is displayed. If Cancel is clicked, this window is closed and the couch pedestal is unlocked.
Continue to Destination? To continue to the intended destination, click Yes. To return to the starting position, click No.	Informs user the couch movement has stopped. If Yes is clicked, this window is closed and the couch continues to the intended destination. If No is clicked, this window is closed and the couch returns to the starting position. If Cancel is clicked, this window is closed and the couch does not move.
Couch Pedestal Location Validation Error(s). The Couch Pedestal values cannot be locked until the following issues are correct.	Informs user there is a problem with one or more of the Current Couch Pedestal Location values. The incorrect values are displayed. When OK is clicked, this window closes.
Current Patient Mismatch. The current patient MR Number does not match the patient MR Number in the import file. The current patient will be closed before the import process continues.	Informs user the current patient does not match the patient in the file selected for import. If OK is clicked, the current patient is closed and import proceeds. If Cancel is clicked, the import process is cancelled.
Couch Pedestal Outside Threshold. The following values are outside the configured threshold compared to the values from the previous move. Would you like to continue and use these values?	Warns the user one or more of the Current Couch Pedestal Location text fields contain a value outside the configured threshold compared to the values from the selected course's previous move. If Yes is clicked, the Current Couch Pedestal Location text fields become read-only, and the Lock Pedestal Values button becomes Unlock Pedestal Values . If No is clicked, user returns to the first text box containing a value outside the configured threshold.

12 System Messages

Message	Definition
Currently-Loaded Patient Will Be Closed. The currently-loaded patient will be closed before loading this patient.	Informs user the currently-loaded patient will be closed. If OK is clicked, the currently open patient is closed and the selected patient is loaded. If Cancel is clicked, user returns to previous window.
Delete IGRT Settings? The selected IGRT configuration will be deleted.	Asks user to confirm intent to delete IGRT System Configuration. If OK is clicked, IGRT configuration is removed from the IGRT display. If Cancel is clicked, the configuration will not be deleted. If default IGRT system is selected for deletion then user will be reminded to select a new default system before closing Configurations and Settings window.
Delete Patient(s)? The selected patient(s) will be deleted. This action cannot be undone.	Asks user to confirm if their intent is to delete the selected patient(s). If OK is clicked, patient(s) will be deleted. This action cannot be undone. If Cancel is clicked, patient(s) are not deleted.
Department Query Failed. Unable to query departments from MOSAIQ.	Informs user the Varian MOSAIQ Department Query Failed. Click OK to return to the configuration screen.
Duplicate Access Key. The <IGRT System Name> IGRT Coordinate System Access Key matches an existing IGRT Coordinate System's Access Key so the value has been cleared.	Informs user there an IGRT system in the import file has the same Access Key as an existing IGRT system. When OK is clicked, the IGRT Coordinate System is imported, the Access Key value is removed and the import configuration procedure continues.
Duplicate Course Value. The current Course value is a duplicate of a previously-entered value. Please enter a new value.	Informs user there is a problem with the Course value. The Course value is not unique. When OK is clicked, this window closes.
Error. Cannot set pivot point unless all couch coordinates are at zero. Do you want to move to zero now?	Notifies user the pivot point cannot be set unless all coordinates are zero. When OK is clicked, this window is closed.
Error. Cannot move until the pivot point is set correctly. Please Lock Pedestal Values to reset the pivot point and try again.	Notifies user the pivot point is set incorrectly. When OK is clicked, this window is closed.
Error. The file containing the patient data could not be found.	Notifies user the file containing the patient data for the patient they selected could not be found. When OK is clicked, this window is closed.
Error. Initialization of the Protura hardware has failed. Please make sure the hardware is turned on and ready.	Notifies user the initialization of the Protura hardware failed. When Retry is clicked, this window closes and user will need to ensure the hardware is turned on and ready for moves. When Exit Protura is clicked, the application exits.
Export Configuration File Error. The configuration file cannot be written. The export will be aborted.	Notifies user the configuration file cannot be created. When OK is clicked, this window closes and configuration export procedure aborts.
Export Configuration Error. The configuration must be completed before it can be exported. The export will be aborted.	Notifies user the configuration must be completed. When OK is clicked, this window closes and configuration export procedure aborts.

12 System Messages

Message	Definition
Failed to Connect - Waiting to Reconnect. The connection to the Elekta System has failed. Click Abort to use Protura without the Elekta System. Attempting to Reconnect to Linac - Every 5 seconds.	Notifies user connection to configured Elekta system failed. The message will automatically be removed if connection is restored. When Abort is clicked, the system stops trying to connect to the Linac until Protura is restarted. The system will automatically try to reconnect every 5 seconds.
Failed to Connect. The connection to the Varian 4DTC System has failed. Click the Retry button to continue trying to connect.	Notifies user connection to configured Varian 4DTC system failed. When Retry is clicked, this window closes and Protura will retry the connection to Varian 4DTC System. When Cancel is clicked, focus is returned to the main application window.
Failure to Save. Patient data failed to save.	Click OK button to close dialog box and focus is returned to Patient dialog.
Field Content Exceeds Screen Display. The value in the import file from the fields listed below exceeds the displayed field length. The data has been truncated:	Informs user the file selected for import contains field values greater than the length of the display fields and the extraneous data has been truncated. The truncated fields will be listed. When OK is clicked, the window closes and user returns to the main window.
IGRT System Not Found. The IGRT Coordinate System specified for use with the OBI System cannot be found.	Informs user the IGRT Coordinate System specified for use with OBI System cannot be found. When OK is clicked, this window is closed.
IGRT System Not Found. The IGRT Coordinate System specified for use with the XVI Database Interface cannot be found.	Informs user the IGRT Coordinate System specified for use with XVI Database cannot be found. When OK is clicked, this window is closed.
IGRT Coordinate Systems Validation Error(s). The following configuration validation errors exist and must be corrected prior to saving the values:	Informs user one or more of the IGRT Coordinate System values have failed validation checks. When OK is clicked, this window is closed.
Import Configuration Error. The import file contains an IGRT Coordinate System that already exists. Change the name being imported to preserve the existing system.	Informs user one or more of the IGRT Coordinate System file already exists. User can change import file name and continue to import. User can change import file name or change IGRT Coordinate System Name to a value that does not exist. When OK is clicked, this window is closed or can click Skip to bypass IGRT Coordinate System.
Import Configuration Error. Do not change system name to replace the existing system. IGRT Coordinate System Name: <editable text box containing current value> Click OK to proceed or Skip to bypass this IGRT Coordinate System.	Informs user one or more of the IGRT Coordinate System file already exists. User can change import file name and continue to import. User can change import file name or change IGRT Coordinate System Name to a value that does not exist. When OK is clicked, this window is closed or can click Skip to bypass IGRT Coordinate System.
Import Configuration File Error. The configuration file cannot be read. The import will be aborted.	Informs user configuration file cannot be read. When OK is clicked, this window is closed.

12 System Messages

Message	Definition
<p>Import Configuration Validation Error. The Protura Location Name is currently assigned to another system and cannot be imported. Change the Protura Location Name and click OK to continue, or Cancel to abort the import.</p> <p>Protura Location Name: <editable text box containing current value></p>	<p>Informs user the Protura Location Name cannot be imported because assigned to another system. User can change the value in the Protura Location Name text box to a unique value and click OK to complete the configuration import procedure. If user does not change value to a unique value, message box is displayed again.</p> <p>If Cancel is clicked, the configuration import procedure aborts.</p>
<p>Import File Contains Duplicate Fields. The selected file will not be imported because duplicate fields were encountered.</p>	<p>Informs user the file selected for import contains duplicate fields. When OK is clicked, this window is closed.</p>
<p>Import File Contains Invalid Values. The selected file will not be imported because the import file contains invalid values.</p>	<p>Informs user the file selected for import contains invalid values in one or more fields. When OK is clicked, this window is closed.</p>
<p>Import File Exceeds Defined Time Threshold. The selected file contains a date and time value that exceeds the defined system Time Threshold. Do you want to continue to import the file?</p>	<p>Informs user the file selected for import contains date and time values outside the defined system threshold. If Yes is clicked, the import process continues. If No is clicked, the import process is cancelled and user returns to the Import window.</p>
<p>Import File Has Different Couch Pedestal Coordinates. The import file contains Couch Pedestal Coordinates different from the current values. Continuing with the import will overwrite the current values.</p>	<p>Informs user the import file has different couch pedestal coordinates. If OK is clicked, current couch pedestal values will be replaced. If Cancel is clicked, the window closes and the import is cancelled.</p>
<p>Import File Missing Required Fields. The selected file will not be imported because the following required fields are missing or do not contain the required information:</p>	<p>Informs user the file selected for import is missing one or more required fields. The missing fields are displayed. When OK is clicked, this window is closed.</p>
<p>Invalid Date. The date entered is not a valid date.</p>	<p>Informs user a date value was entered incorrectly. When OK is clicked, this window is closed.</p>
<p>Invalid Date Range. The report cannot be generated because the selected date range is invalid.</p>	<p>Informs user there is a problem with the selected date range for the report. When OK is clicked, this window is closed.</p>
<p>Invalid Import File. The selected file will not be imported because the file format is not a valid Import File.</p>	<p>Informs user the format of the selected file is not a valid Import file. When OK is clicked, this window is closed and focus returns to the Import window.</p>
<p>Invalid Patient Data. Protura has received invalid patient data.</p>	<p>Informs user the retrieved patient data has invalid values. When OK is clicked, this window is closed and the application stops reading pedestal data.</p>
<p>Invalid Pedestal Data. Protura has received invalid couch pedestal location data and will stop receiving this data until Protura is restarted.</p>	<p>Informs user the retrieved pedestal location data has invalid values. When OK is clicked, this window is closed.</p>
<p>KV Setup/CBCT Beam Moded Up Without a Patient. A Mode Up of a KV Setup/CBCT Beam was received without a patient being open. If this is not an emergency treatment, reload the patient in the 4DTC.</p>	<p>If this is not an emergency treatment, reload the patient in the 4DTC and click OK.</p>

12 System Messages

Message	Definition
Load New Patient? The patient record was saved. Would you like to close the open patient and load the new patient?	Asks user if the open patient record should be closed, so the newly-created patient can be loaded. If Yes is clicked, newly-created patient is loaded. If No is clicked, user returns to the previous window and newly-created patient is saved but not loaded.
Log File Error. Unable to open log file. Please resolve this condition and re-run the application.	Informs user the log file contained an error. When OK is clicked, this window is closed and the application closes.
Log File Warning. Unable to archive log file. The log file has been renamed.	Informs user the log file could not create the “year/month” folder or is unable to move the old log file into the “year/month” folder. The renamed log file displays in the message.
MOSAIQ PATID File Not Found. The MOSAIQ PATID File Location is not valid.	Connection to the MOSAIQ PATID File Location has been lost. Click OK to return to the main application window.
MOSAIQ Patient Not Found. Data for the patient selected in the MOSAIQ system cannot be found.	Informs user Protura failed to find selected patient in MOSAIQ database. If Retry is clicked, Protura will retry the query for patient data to the MOSAIQ System. If Cancel is clicked, this window is closed and focus is returned to the main application window.
MR Number Not In System. The MR Number in the import file is not in the system. Would you like to create a new patient record?	Informs user the MR number being imported is not in the system. Asks user if a new patient record should be created. If Yes is clicked, a new patient record is created, the patient record is loaded, and the import continues. If No is clicked, a new patient record is not created and import is cancelled.
Move Error. The system has experienced a move error and must be re-initialized. This will result in a move to the Zero Position. Click OK to begin initialization. After initialization, please reposition the patient and try again.	Informs user a move error has occurred. When OK is clicked, this window is closed.
Move Failed. The Zero Position event failed to complete. The Protura hardware must be re-initialized which will result in a move to the Zero Position. Click OK to begin the initialization.	Informs user the move to zero failed. When OK is clicked, the Protura application sends an Initialize command to the hardware and this window is closed.
Move Successful. The move was successful. [Is the patient ready for treatment?] [Have pedestal shifts been accepted in the 4DTC and is the patient ready for treatment?]	Informs user the move was successful and asks if the patient is ready for treatment. If Yes is clicked, Ready for Treatment message box is displayed. If No is clicked, the message box closes.
Move to Zero Position. Changing the Couch Pedestal Location will require moving the Protura hardware to the Zero Position. Do you want to continue?	Informs user Protura requires a move to Zero Position . If OK is clicked, Protura will move to Zero Position and returns to the main window. If Cancel is clicked, Protura does not move, user returns to the main window and Current Couch Pedestal Location panel fields remain read only.
New Patient. Is the new patient to be treated using the Protura System?	Click Yes and patient will be marked as a Protura patient. Registrations will be looked for and 6DOF will be calculated. Click No and patient will be marked as a non-Protura patient. Registrations will not be looked at and 6DOF will not be calculated.

12 System Messages

Message	Definition
No Access Keys Found. At least one IGRT system needs an Access Key in order to use the Remote Control feature.	Informs user at least one IGRT system needs an Access Key in order to use the Remote Control feature. When OK is clicked, this window is closed.
No Default IGRT System Defined. No IGRT Coordinate Systems are designated as the default system. Be sure to select a default IGRT system before closing the Configurations window.	Informs user a default IGRT Coordinate System is not selected and reminds user to select a default IGRT system before closing the Configuration window. When OK is clicked, this message box is closed.
No Default Printer. A default Windows printer could not be found. Please configure a default printer.	Informs user a default printer could not be found. When OK is clicked, this window is closed.
No Results. The report contains no data for the selected criteria.	Notifies user there are no results from a requested report. If OK is clicked, this window is closed.
No Shift Data Found. No shift data was found for the current patient. Ensure correct patient is loaded and shift data was saved.	Notifies user expected shift data was not found. When OK is clicked, focus is returned to the main application window.
Original Move Out of Range. Proposed move too large. If the move was reduced by 20.1% the move would be possible.	Notifies user proposed move is too large and offers user two options. Use Reduced Values button will move Protura to reduced values settings shown on message box. Reduced values will then appear in Proposed Values fields. Select Move button to move Protura. Repositioned Patient button can be selected and message dialog box will close. Protura will return to main window.
Patient Data Conflict. The import record contains data which conflicts with an existing patient record. If you proceed with the import, the following values will be replaced by the values in the import file.	Warns user the MR Number in the import record matches an existing patient record, however the demographic data does not match. The fields to be replaced are displayed. If OK is clicked, the import proceeds, existing values will be replaced with the new file values. If Cancel is clicked, the existing values are not changed and import is cancelled.
Patient Data Error. MR Number, Last Name and First Name fields are required.	Informs user the fields are required. When OK is clicked, this window is closed.
Patient Data Validation Error(s). The following validation errors exist and must be corrected prior to saving the values:	Informs user one or more patient data values are incorrect. The validation errors will be listed in the message box. When OK is clicked, this window is closed.
Patient List Error. The patient data location is unavailable.	Informs user one or more patient data values are incorrect. When OK is clicked, this window is closed.
Pedestal has Moved From Original. The pedestal has moved from original position. Move pedestal back to the original location to continue.	If Cancel is clicked, this message is closed and the couch pedestal is unlocked.
Pedestal has Moved From Locked. The Couch Pedestal has moved from its locked location. Please reposition the pedestal and try the move again.	Informs user the couch pedestal has moved from its locked location. When OK is clicked, this window is closed.

12 System Messages

Message	Definition
Proposed Values Validation Error(s). The move cannot be initiated until the following issues are correct.	Informs user there is a problem with one or more of the IGRT Proposed Values. The incorrect values are displayed. When OK is clicked, this window closes.
Protura Already Running. Protura is already running under a different user. Please quit that Protura before starting another.	Informs user that Protura is already running by a different user. Close the existing session and launch Protura again. Click OK to go back to main screen.
Protura Application Error. The Protura System Settings file has been corrupted. Do you want to delete and recreate the file with default settings?	Informs user the System Settings configuration file has been corrupted. If Yes is clicked, the system will delete ProturaSystemSettings.config file and regenerate a default file. If No is clicked, the application exits.
Protura Application Error. The system list configuration file is currently open by another system. Please try again.	When OK is clicked, the window is closed and focus returns to the Configurations window.
Protura Application Error. The following file(s) have been corrupted. Please delete the following file(s) and re-run the application:	Informs user the displayed IGRT Settings configuration file(s) has been corrupted. When OK is clicked, the application exits.
Protura Authorized. Treatment may be in process and system is Locked. This window will close when the field is cleared.	Informs user that Varian 4DTC is being authorized for treatment and Protura is locked. There is no way for the user to close this window.
Protura Hardware Error. The Protura hardware has powered off or network communication has failed. Upon resuming communication, it may be necessary to re-initialize the hardware which will result in the couch moving to zero.	Informs user the application has lost communication with Protura hardware. When OK is clicked, the window is closed and the application waits for communication to resume.
Protura Hardware Requires Initialization. The Protura hardware must be initialized. If the Protura hardware is not already in the Zero Position, initialization will result in a move to the Zero Position. Press OK to begin the initialization.	Informs user Protura must be re-initialized. Click OK , Protura will re-initialize.
Protura Not in Zero Position. Protura is not in the Zero Position from a prior patient move.	Informs user Protura is not in Zero Position. Click Zero Position to move. Click Leave in Shifted State button to return to the main application window.
Ready for Treatment. Ready for Treatment, system is locked. To exit treatment mode, click UNLOCK.	Informs user Protura is ready and treatment may begin. Click UNLOCK once treatment is complete or to unlock the system and return to the main window. When user returns to the main window, the Proposed Values are reset to zero.
Ready to Authorize. Awaiting VARIAN system to be moved into position for the next treatment field. Click UNLOCK to exit ready state.	Click UNLOCK to exit. Screen will close when UNLOCK has been clicked.
Re-alignment Required. This change will require the Couch Pedestal to be re-aligned.	Notifies user changing the change being made will require couch pedestal re-alignment. If OK is clicked, the change is retained. If Cancel is clicked, the previous values are restored.

Message	Definition
<Record and Verify> Patient Not Found. Data for the patient selected in the <Record and Verify> system cannot be found.	Click Retry and Protura will query for patient data to the <Record and Verify> system again. Click Cancel to exit and return to the main application window.
Replace Couch Pedestal Location? Would you like to replace the existing Couch Pedestal Location values with the values from the selected Course?	Asks user whether the existing Couch Pedestal Location values should be replaced with the values from the newly-selected Course. If Yes is clicked, the values will be replaced. If No is clicked, the values stay the same.
Reset Auto Load/Zero. Changing Couch Pedestal Coordinate settings will require resetting the Auto Load/Zero configuration settings. Do you want to continue?	If Yes is clicked, the Couch Pedestal changes are allowed, Auto Load / Zero function is disabled. All auto filled fields are cleared and saved. If No is clicked, this window is closed and previous setting or value is restored.
Shift data calculation failed. Unable to calculate shift data. Either re-select Save Match or enter shift values manually.	Informs user that the shift data was not calculated. Re-select Save Match or enter shift values manually. Click OK to return to the main screen.
Test Procedure Aborted. The Test Procedure has been aborted. The Couch will return to the Zero Position.	When the OK button is clicked, this window is closed and focus returns to the Test Procedure window. The Couch returns to the Zero Position .
Test Procedure to Begin. This is a test procedure. Ensure there is not a patient on the couch. Click Ok to proceed or Cancel to abort the test.	When the OK button is clicked, this window is closed and the Test Procedure begins. If Cancel is clicked, this window is closed and focus returns to the Test Procedure window without starting Test Procedure.
Touch Guard Activated. Touch guard has been activated, Protura hardware cannot be moved until touch guard has cleared.	Informs user Protura detected a touch guard signal.
Treatment in Process. Treatment in Process, system is locked. This window will close after treatment is complete.	Informs user treatment is in process. This window will close once treatment finishes, if treatment is interrupted or if connection to Elekta is lost for 10 seconds.
Unable To Delete Patients. The following patient(s) cannot be deleted because they are currently displayed in the Patient Data Panel of the current Protura application or another Protura application on the network:	Informs user one or more patients selected for deletion cannot be deleted because they are open. Patient files unable to be deleted are displayed. When OK is clicked, patients are not deleted. The patients selected for deletion, but not displayed, will be deleted.
Unable To Delete Patients. The following patient(s) cannot be deleted because their files are not available possibly due to a network communication problem:	Informs user one or more patients selected for deletion cannot be deleted because the files do not exist or are open. Patient files unable to be deleted are displayed. When OK is clicked, this window is closed. The patient list is refreshed, which may result in an empty list if the network share is not available.
Unable to Edit Configuration. The currently loaded patient must be closed before making changes to Protura configuration or settings. Would you like the patient record to be closed?	Informs user configuration settings cannot be unlocked with a patient loaded. When Yes is clicked, this message is closed, the currently loaded patient record is closed and the Configuration Password window. When No is clicked, this message is closed, the currently loaded patient record is not closed and you are returned to the Configuration window.

12 System Messages

Message	Definition
Unable to get Pedestal Location. We were not able to get valid Pedestal values from the Varian 4DTC. Please make sure the correct patient is loaded, that a beam is moded up, and that the values are within range.	Informs user valid pedestal values cannot be retrieved from the Varian 4DTC. Click OK to return to the main screen and the Lock Pedestal request is aborted.
Unable To Import File – CRC-32 Check Failed. The selected file will not be imported because the CRC-32 check on the import file failed.	Informs user the CRC-32 check failed on the import file and will not be imported. When OK is clicked, this window is closed.
Unable To Load Patient; Patient In Use. The selected patient data will not be loaded. Another Protura application has this data in use.	Informs user the patient file is in use by another Protura application and will not be loaded. This message box displays when the user attempts to load a patient file meeting this criteria. When OK is clicked, this window is closed.
Unable to Report on the Following Patient(s). The following patient(s) cannot be included in the report because they are currently displayed in the Patient Data Panel of another Protura application on the network: The report will be generated without these patients.	Informs user one or more patients selected for reporting are unavailable because they have been deleted or already in use. The reasons displayed will be either Deleted or In Use . When OK is clicked, the report for patients selected, but not displayed, will be generated.
Unable to Retrieve Plan File. The Plan File could not be retrieved. Clear and Mode Up the beam again.	Informs user Plan File cannot be retrieved. Click OK and main screen is displayed.
Unsaved Changes. Changes made have not been saved. Do you want to save changes?	If Yes is clicked, changes are saved and user returns to the main window. If No is clicked, changes are discarded, and the user will return to the previous window. If Cancel is clicked, this message is closed, and the user will return to the previous window.
Unsupported Monitor Resolution. The current monitor resolution is not supported. The supported monitor resolution is 1280x1024.	Informs user the detected display resolution is unsupported and may impact application usability. When OK is clicked, the application exits.



CEpartner4U
Esdoornlaan 13
3951 DB Maarn, Netherlands
Ph: +31 (0) 6-516.536.26

CIVCO

CIVCO RADIOTHERAPY
1401 8th Street SE, Orange City, IA 51041 USA
712.737.8688, 800.842.8688
info@civcort.com

WWW.CIVCORT.COM

COPYRIGHT © 2020 ALL RIGHTS RESERVED. CIVCO IS A REGISTERED TRADEMARKS OF CIVCO MEDICAL SOLUTIONS. PROTURA IS A TRADEMARK OF CIVCO RADIOTHERAPY. ALL OTHER TRADEMARKS ARE PROPERTY OF THEIR RESPECTIVE OWNERS. PRINTED IN USA.

093-0288

2020.12.11